

M23 female 90° with cable

PUR 16x0.5+3x1.0 gy UL/CSA+drag ch. 5m

Female 90°

M23, 19-pole

19-pole used

for 8-way distribution boxes, 5-pole

Further cable lengths on request.

Plastic housings with good resistance against chemicals and oils.

The resistance to aggressive media should be individually tested for your application. Further details on request.

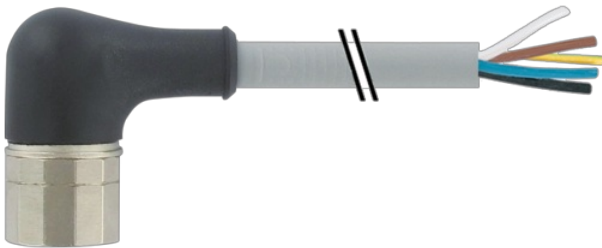
[Link to Product](#)**Illustration**

15	white
7	gray/pink
5	green
4	red/blue
16	yellow
8	white/green
3	gray
14	brown/green
17	pink
9	white/yellow
2	red
13	yellow/brown
11	black
10	white/gray
1	violet
18	gray/brown
19	brown 1.0mm ²
6	blue 1.0mm ²
12	green/yellow 1.0mm ²

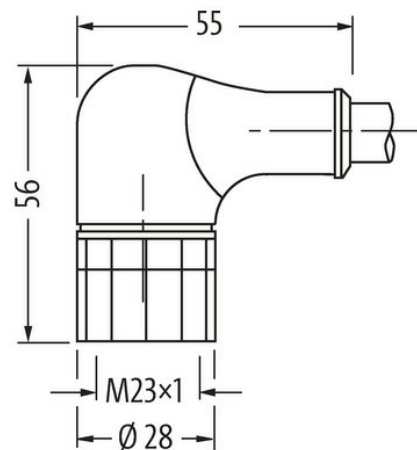
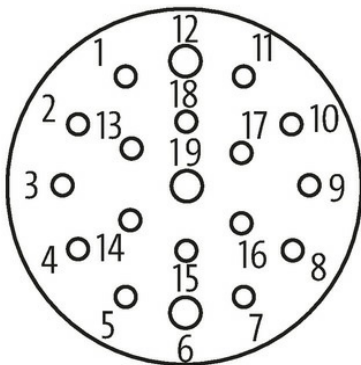
Female

Product may differ from Image

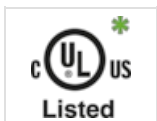

* only for products with UL/CSA approved cable

Form

Form 23351

Technical Data

Operating voltage max. 125 V AC/DC

Rated surge voltage	2.0 kV
Operating current per contact	7.5 A (1.0 mm ²); 3.5 A (0.5 mm ²)
No. of poles	19
Material group	IEC 60664-1, category I
Locking of ports	Screw thread (M23×1 mm) recommended torque 2.0 Nm, self-securing
Compression gland	M23 (SW27)
Protection	IP67 inserted and tightened (EN 60529)
Material	PUR
Locking material	Brass, nickel plated
suitable for corrugated tube (internal Ø)	16 mm

General data

Pollution Degree	3
Temperature range	-25...+85 °C, depending on cable quality

Cables

Cable identification	452
Approval (cable)	cRUus (AWM style 20549/10042); CE compliant
Cable weight [g/m]	231 g
Material (wire)	Cu wire, bare
Resistor (core)	max. 39 Ω/km (0.5 mm ²); max. 20 Ω/km (1.0 mm ²); (20 °C)
Single wire Ø (core)	0.1 mm
Construction (core)	64× 0.1 mm (0.5 mm ²), 128× 0.1 mm (1.0 mm ²); (multi-strand wire class 6)
Diameter (core)	16× 0.5 + 3× 1.0 mm ²
AWG	similar to AWG 20 (0.5 mm ²); similar to AWG 17 (1.0 mm ²)
Material (wire isolation)	TPE-E
Shore hardness (wire isolation)	55 ±3 D
Wire-Ø incl. isolation	1.6 mm ±5% (0.5 mm ²); 2.1 mm ±5% (1.0 mm ²)
Material (jacket)	PUR
Material property (jacket)	CFC-, halogen-, cadmium-, silicone- and lead-free, matt, low-adhesion, machine easy to process, abrasion-resistant, hydrolysis and microbial resistant
Shore hardness (jacket)	94 ±5 A
Outer-Ø (jacket)	11.5 mm ±5%
Color (jacket)	gray
chemical resistance	good resistance to oil, gasoline and chemicals
thermal resistance	flame retardand UL 1581 Section 1090 (H), CSA FT2 / IEC 60332-2-2
Nominal voltage	300/300 V AC
Test voltage	2000 V AC
Current load capacity	to DIN VDE 0298-4
Temperature range (mobile)	-20...+90 °C
Bend radius (moving)	10× outer Ø
No. of bending cycles (C-track)	max. 5 Mio.
Traversing distance (C-track)	max. 5 m (horizontal)
Travel speed (C-track)	max. 2 m/s
Acceleration (C-track)	max. 5 m/s ²

Commercial data

country of origin	DE
customs tariff number	85444290
EAN	4048879187848
eClass	27279218
Packaging unit	1.000