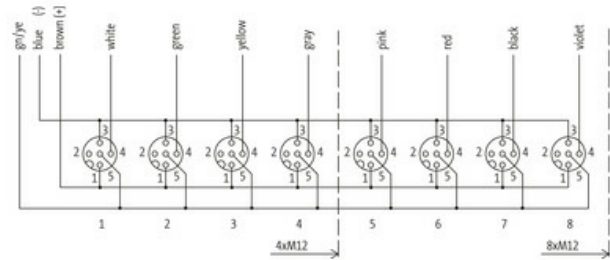
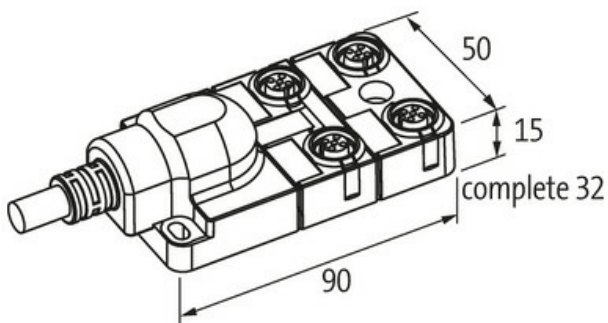

EXACT12, 4XM12, 4 POLE MOULDED CABLE

5.0m PUR/PVC 4X0.34+3X0.75

PUR/PVC

5.0 m

[Link to Product](#)**Illustration**

M12-Females 4-pole

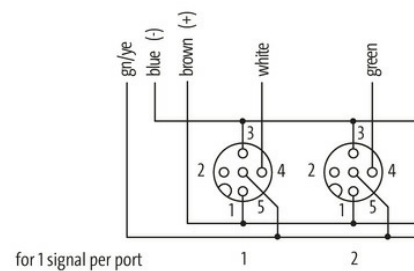
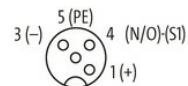

Product may differ from Image

**Technical Data**

Operating voltage	125 V AC/DC
Operating current per contact	max. 4 A
Locking of ports	Screw thread (M12x1 mm)
Protection	IP65/IP67
Housing	Plastic, flame retardant

General data

Temperature range	-20...+70 °C, depending on cable quality
-------------------	--

Cables

No./diameter of wires	4x 0.34 + 3x 0.75 mm ²
Wire isolation	PVC
C-track properties	2 Mio.
Outer Ø	7.4 mm ±5%
Cable identification	333

The information in this brochure has been compiled with the utmost care. Liability for the correctness completeness and topicality of the information is restricted to gross negligence. Version: 03/22

Cable Type	2 (PUR/PVC)
Cable number	333
Approval (cable)	UL (AWM-Style 21441/10955), CE conform
Cable weight [g/m]	91,3 g
Material (wire)	Cu wire, bare
Resistor (core)	max. 57 Ω/km (0.34 mm ²), max. 26 Ω/km (0.75 mm ²); (20 °C)
Single wire Ø (core)	0.15 mm (0.34 mm ²); 0.2 mm (0.75 mm ²)
Construction (core)	19× 0.15 mm (0.34 mm ²); 24× 0.2 mm (0.75 mm ²); (multi-strand wire class 5)
Diameter (core)	4× 0.34 + 3× 0.75 mm ²
AWG	similar to AWG 22 (0.34 mm ²); similar to AWG 18 (0.75 mm ²)
Material (wire isolation)	PVC
Material property (wire isolation)	CFC-, cadmium-, silicone- and lead-free
Shore hardness (wire isolation)	43 ±5 D
Wire-Ø incl. isolation	1.3 mm ±5% (0.34 mm ²); 1.8 mm ±5% (0.75 mm ²)
Color/numbering of wires	wh, gn, ye, gr+br, bl, gnye longitudinally striped
Shield	no
Material (jacket)	PUR/PVC
Shore hardness (jacket)	87 ±5 A
Outer-Ø (jacket)	7.4 mm ±5%
Color (jacket)	gray
Jacket Color	gray
chemical resistance	good resistance to oil, gasoline and chemicals (EN 60811-404)
Nominal voltage	U0/U 300/300 V AC
Test voltage	2000 V AC
Current load capacity	to DIN VDE 0298-4
Temperature range (fixed)	-30...+80 °C
Temperature range (fixed)	-30...+80 °C
Temperature range (mobile)	-5...+70 °C
Temperature range (mobile)	-5...+70 °C
Bend radius (fixed)	5× outer Ø
Bend radius (moving)	12× outer Ø
Bend radius (moving)	12× outer Ø
No. of bending cycles (C-track)	max. 2 Mio. (25 °C)
Travel speed (C-track)	max. 2 m/s
Acceleration (C-track)	max. 10 m/s ²
Material (jacket)	PUR/PVC

Contact Layout

PIN 1	(+)
PIN 3	(-)
PIN 4	(NO)/(S1)
PIN 5	(Earth)

Commercial data

country of origin	DE
customs tariff number	85444290
EAN	4048879055987
eClass	27279219
Packaging unit	1.000