

PRE-WIRED CAP FOR EXACT8, 10XM8, 3 POLE

10.0m PUR/PVC 10x0,34+2x0,75

for 10-way distribution box, 3-pole

Further cable lengths on request.

Plastic housings with good resistance against chemicals and oils.

The resistance to aggressive media should be individually tested for your application. Further details on request.

PUR/PVC

10.0 m

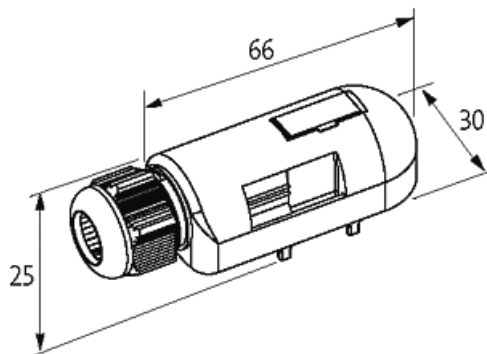
[Link to Product](#)**Illustration**

Product may differ from Image

M8-Females 3-pole

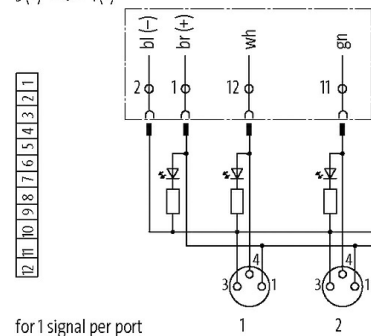
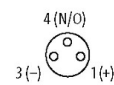

for 1 signal per port

**Technical Data**

Total current	max. 8 A
Housing	Plastic, flame retardant

General data

Temperature range	-20...+80 °C, depending on cable quality
-------------------	--

Cables

Cable number	385
--------------	-----

No./diameter of wires	10× 0.34 + 2× 0.75 mm ²
Wire isolation	PVC (br, bl, wh, gn, pk, ye, bk, gr, rd, vi, grpk, rdbl)
C-track properties	2 Mio.
Jacket Color	gray
Material (jacket)	PUR/PVC
Outer Ø	8.3 mm ±5%
Bend radius (fixed)	5× outer Ø
Bend radius (moving)	10× outer Ø
Temperature range (fixed)	-30...+80 °C
Temperature range (mobile)	-5...+60 °C
Color (jacket)	gray

Commercial data

country of origin	CZ
customs tariff number	85444290
EAN	4048879056755
eClass	27143423
Packaging unit	1