

M8 male 0° snap-in/M12 fem. 90° A-cod.screw-in LED

PUR 3x0.25 gy UL/CSA 1.5m

Male straight – female 90°

M8 (Snap In) – M12, 3-pole

2× LED (PNP), (NPN) on request

Art-No. 7005 - M12 Lite - (plastic hexagonal screw) on request

Further cable lengths on request.

Plastic housings with good resistance against chemicals and oils.

The resistance to aggressive media should be individually tested for your application. Further details on request.

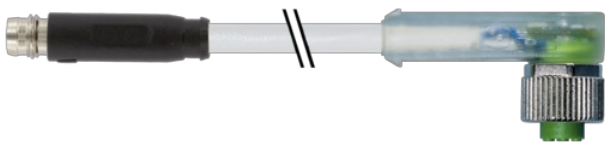
[Link to Product](#)**Illustration**

Male

Female

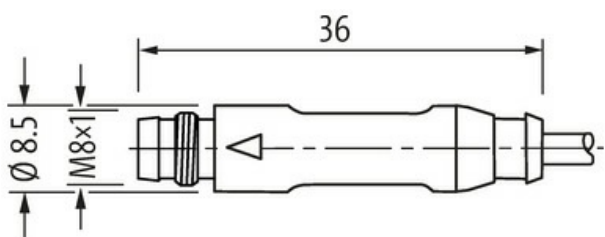
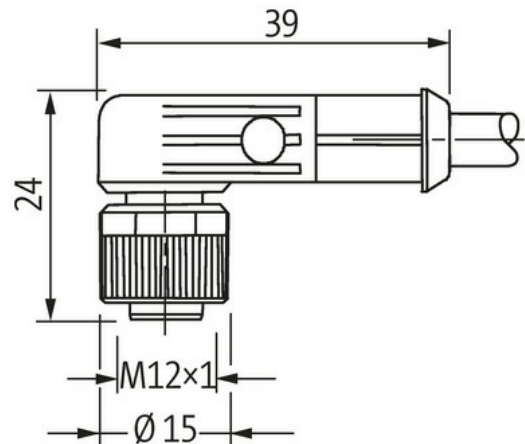
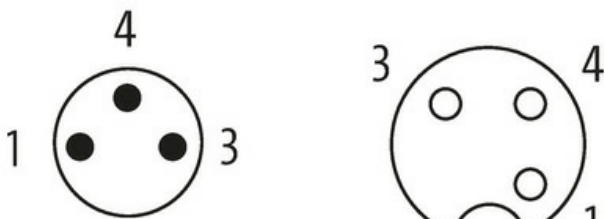

Product may differ from Image



* only for products with UL/CSA approved cable

Form	
Form	88401
Technical Data	
Operating voltage	24 V DC $\pm 25\%$
Operating voltage (only UL listed)	max. 30 V DC
Rated surge voltage	0.8 kV
Operating current per contact	max. 4 A
Material group	IEC 60664-1, category I
Coding	M12, A-coded
LED display	yellow/green
Locking of ports	Screw thread (M12 \times 1 mm) recommended torque 0.6 Nm, self-securing, M8 (Snap In)
Compression gland	M12 (SW13)
Protection	IP65, IP66K, IP67 (M12) - IP65 (M8)
Material	PUR
Locking material	Zinc die casting, matte nickel plated (M12)
suitable for corrugated tube (internal \varnothing)	M12 (10 mm); M8 (6.5 mm)
General data	
Standards	DIN EN 61076-2-101 (M12), DIN EN 61076-2-104 (M8)
Pollution Degree	3
Temperature range	-25...+85 °C, depending on cable quality
Cables	
Cable identification	220
Cable Type	2 (PUR/PVC)
Approval (cable)	UL (AWM-Style 20549/1731), CSA; CE conform
Cable weight [g/m]	26,62 g
Material (wire)	Cu wire, bare
Resistor (core)	max. 79 Ω /km (20 °C)
Single wire \varnothing (core)	0.1 mm
Construction (core)	32 \times 0.1 mm (multi-strand wire class 6)
Diameter (core)	3 \times 0.25 mm ²
AWG	similar to AWG 24
Material (wire isolation)	PVC
Material property (wire isolation)	CFC-, cadmium-, silicone- and lead-free
Shore hardness (wire isolation)	43 \pm 5 D
Wire- \varnothing incl. isolation	1.25 mm $\pm 5\%$
Color/numbering of wires	br, bk, bl
Stranding combination	3 wires twisted
Shield	no
Material (jacket)	PUR
Material property (jacket)	CFC-, halogen-, cadmium-, silicone- and lead-free, matt, low-adhesion, machine easy to process, abrasion-resistant, hydrolysis and microbial resistant
Shore hardness (jacket)	85 \pm 5 A
Outer- \varnothing (jacket)	4.3 mm $\pm 5\%$
Color (jacket)	gray
Cable labeling	see frame delivery specifications 7000-00000-001
chemical resistance	good resistance to oil, gasoline and chemicals
Nominal voltage	UL 300 V AC
Test voltage	2000 V AC

The information in this brochure has been compiled with the utmost care.

Liability for the correctness completeness and topicality of the information is restricted to gross negligence. Version: 03/22

Current load capacity	to DIN VDE 0298-4
Temperature range (fixed)	-30...+80 °C
Temperature range (mobile)	-5...+80 °C
Bend radius (fixed)	10× outer Ø
Bend radius (moving)	15× outer Ø
No. of bending cycles (C-track)	max. 2 Mio. (25 °C)
Travel speed (C-track)	max. 3.3 m/s
Acceleration (C-track)	max. 5 m/s ²

Commercial data

country of origin	DE
customs tariff number	85444290
EAN	4048879120265
eClass	27279218
Packaging unit	1.000