



Main

Range of product	Lexium integrated drive
Product or component type	Motion integrated drive
Device short name	ILS
Motor type	3-phase stepper motor
Number of motor poles	6
Network number of phases	Single phase
[Us] rated supply voltage	24 V 48 V
Network type	DC
Communication interface	Integrated Ethernet/IP
Length	247.3 mm
Winding type	Medium speed of rotation and medium torque
Electrical connection	Industrial connector
Holding brake	With
Gear box type	Without
Nominal speed	200 rpm at 48 V 100 rpm at 24 V
Nominal torque	6 N.m
Holding torque	6 N.m 6 N.m (holding brake)

Complementary

Transmission rate	125, 250, 500 kbauds
Mounting support	Flange
Motor flange size	85 mm
Number of motor stacks	3
Centring collar diameter	60 mm
Centring collar depth	2 mm
Number of mounting holes	4
Mounting holes diameter	6.5 mm
Circle diameter of the mounting holes	99 mm
Feedback type	Index pulse
Shaft end	Untapped
Second shaft	Without second shaft end
Shaft diameter	14 mm
Shaft length	30 mm
Supply voltage limits	18...55 V
Current consumption	5000 mA (maximum continuous)
Associated fuse rating	16 A
Commissioning interface	RS485 Modbus TCP (9.6, 19.2 and 38.4 kbauds)
Input/Output type	4 signals (each be used as input or output)
Voltage state 0 guaranteed	-3...4.5 V
Voltage state 1 guaranteed	15...30 V

Discrete input current	2 mA at 24 V for 24 V signal interface 10 mA at 24 V for safety input
Discrete output voltage	23...25 V
Maximum switching current	200 mA total 100 mA per output
Protection type	Overload of output voltage Safe torque off Short circuit of the output voltage
Peak stall torque	6 N.m
Continuous stall torque	6 N.m
Speed feedback resolution	20000 points/turn
Accuracy error	+/- 6 arc min
Rotor inertia	3.5 kg.cm ²
Maximum mechanical speed	2000 rpm
Maximum radial force Fr	110 N
Maximum axial force Fa	30 N (force pressure) 170 N (tensile force)
Service life in hours	20000 h of bearing :
Brake pull-in power	22 W
Brake release time	40 ms
Brake application time	20 ms
Marking	CE
Type of cooling	Natural convection
Product weight	6.5 kg

Environment

Standards	EN 50347 EN 61800-3:2001, second environment EN 61800-3 : 2001-02 EN/IEC 50178 EN/IEC 61800-3 IEC 60072-1 IEC 61800-3, Ed 2
Product certifications	CUL TÜV UL
Ambient air temperature for operation	0...40 °C without derating > 40...55 °C with power derating of 2 % per °C
Permissible ambient air temperature around the device	110 °C (motor) 105 °C (power amplifier)
Ambient air temperature for storage	-25...70 °C
Operating altitude	<= 1000 m without derating
Relative humidity	15...85 % without condensation
Vibration resistance	20 m/s ² (f = 10...500 Hz) for 10 cycles conforming to EN/IEC 60068-2-6
Shock resistance	150 m/s ² for 1000 shocks conforming to EN/IEC 60068-2-29
IP degree of protection	IP54 total except shaft bushing conforming to EN/IEC 60034-5 IP41 shaft bushing conforming to EN/IEC 60034-5

Offer Sustainability

Sustainable offer status	Green Premium product
RoHS (date code: YYWW)	Compliant - since 0931 - Schneider Electric declaration of conformity
REACH	Reference not containing SVHC above the threshold
Product environmental profile	Available Download Product Environmental
Product end of life instructions	Available Download End Of Life Manual

Integrated Drive with Holding Brake

Dimensions

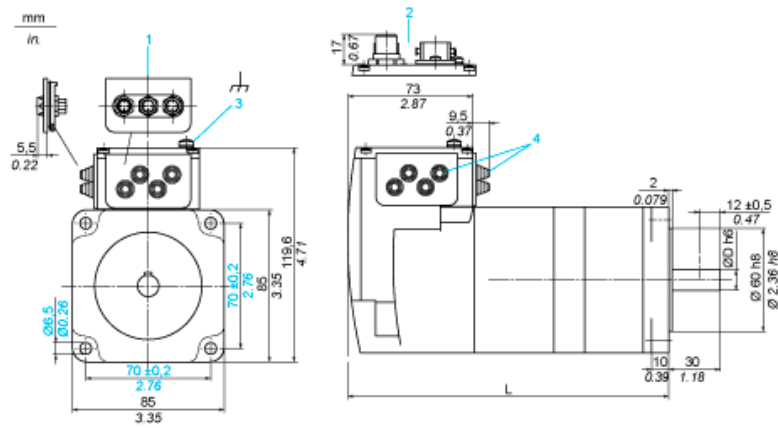

- 1 Accessories: I/O signal insert with industrial connectors
- 2 Option: industrial connectors
- 3 Earth (ground) terminal
- 4 Accessories: cable entries $\varnothing = 3 \dots 9 \text{ mm}/0.12 \dots 0.35 \text{ in.}$
- L 247.3 mm/9.74 in.
- D 14 mm/0.55 in.

Connection Example with 4 I/O Signals



Torque Characteristics

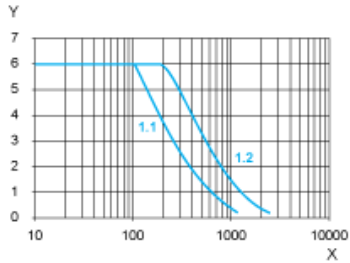

- X Speed of rotation in rpm
- Y Torque in Nm
- 1.1 Max. torque at 24 V
- 1.2 Max. torque at 48 V