

MPOT POTENTIOMETER MODULE

5K-Ohm/3600° /10 turn

10-turn potentiometer

5 k Ω

The 10-turn potentiometer has a decimal scale and locking lever

Link to Product

Illustration

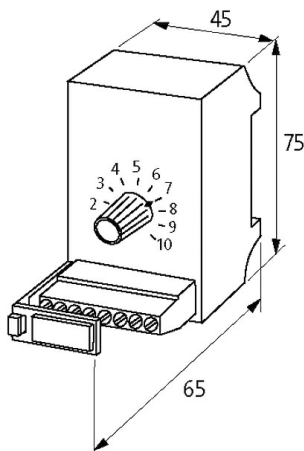
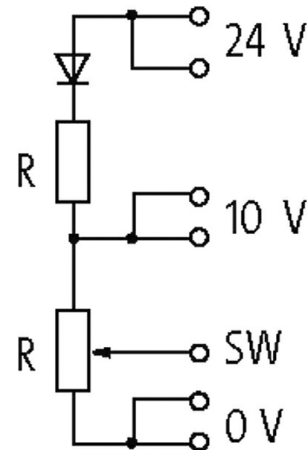

Product may differ from Image

Technical Data

Resistance tolerance	±5%
Linearity	±0.25%
Power (potentiometer)	1.4 W (2 W/40 °C)
Power (resistor)	0.25 W

General data

Mounting method	DIN-rail mountable (EN 60715)
Temperature range	0...+60 °C
Dimensions H×W×D	75×45×65 mm

Description

Functional description

The potentiometer modules are fitted with standard values. They are available as 270° potentiometer and as 10-turn potentiometer with fine adjustment. They can be operated with 10 V DC or 24 V DC. A resistor reduces the voltage so that a 24 V DC voltage c

Commercial data

country of origin	CZ
customs tariff number	85334010
EAN	4048879041621
eClass	27371227
Packaging unit	1.000