

Mini (7/8) 5 pole, Male (Ext.) 90° w/ Cable

TPE 5x16AWG ye UL/CSA, TC-ER

Male 90°

7/8" (5-pole)

Power cable

USA

without cable sleeves

Further cable lengths on request.

Plastic housings with good resistance against chemicals and oils.

The resistance to aggressive media should be individually tested for your application. Further details on request.

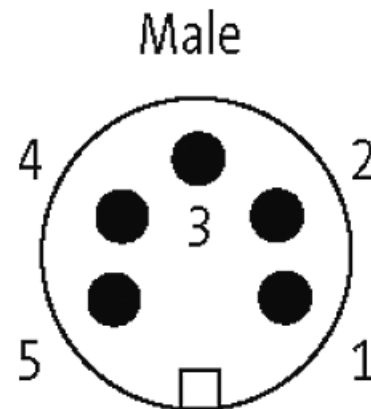
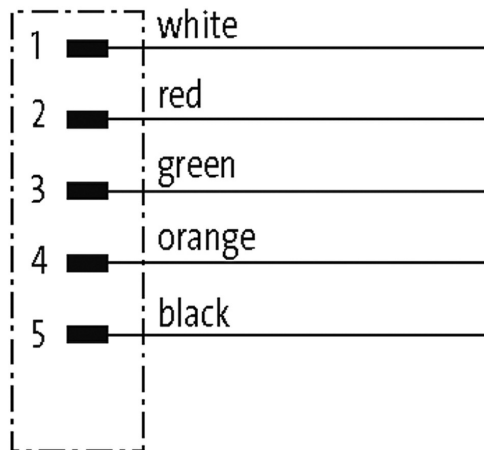
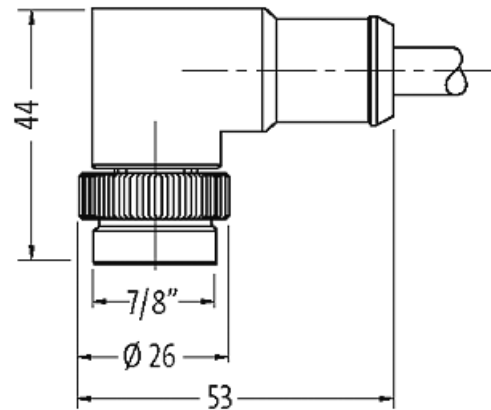
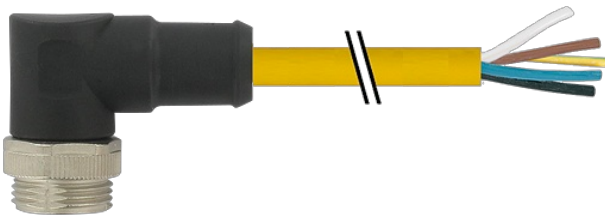
[Link to Product](#)**Illustration**

Product may differ from Image



* only for products with UL/CSA approved cable

Form

Form A5011

Technical Data

Operating voltage max. 600 V AC/DC

Rated surge voltage	4.0 kV
Operating current per contact	max. 9 A
No. of poles	5
LED display	no
Locking of ports	Screw thread 7/8" (recommended torque 1.5 Nm) self-securing
Compression gland	7/8" (SW24)
Protection	IP68 inserted and tightened (EN 60529)
Locking material	Zinc die casting, matte nickel plated
Material	PUR

General data

Mounting method	inserted, tightened
Pollution Degree	3
Temperature range	-25...+80 °C, depending on cable quality

Cables

Cable number	U1D
No./diameter of wires	5× 1.5 mm ²
Wire isolation	PVC (bk, or, gn, rd, wh)
Jacket Color	yellow
Material (jacket)	TPE (UL/CSA)
Outer Ø	9.8 mm ±5%
Bend radius (moving)	10× outer Ø
Temperature range (fixed)	-50...+105 °C
Temperature range (mobile)	-20...+90 °C
Cable identification	U1D
Approval (cable)	UL (AWM-Style 21002/1841), CSA
Cable weight [g/m]	144,10
Material (wire)	Cu wire, bare
Resistor (core)	max. 13.2 Ω/km (20 °C)
Single wire Ø (core)	0.16 mm
Construction (core)	65× 0.16 mm (multi-strand wire class 6)
AWG	similar to AWG 16
Material (wire isolation)	PVC
Wire-Ø incl. isolation	2.6 mm ±5%
Color/numbering of wires	bk, or, gn, rd, wh
Stranding combination	5 wires twisted around central filler
Shield	no
Material (jacket)	TPE
Outer-Ø (jacket)	9.8 mm ±5%
Color (jacket)	yellow
chemical resistance	good resistance to oil, gasoline and chemicals
thermal resistance	flame retardant UL, FT4
Nominal voltage	600 V
Test voltage	6 kV spark test
Current load capacity	NEC (National Electric Code)
Temperature range (fixed)	-50...+105 °C
Temperature range (mobile)	-20...+90 °C
Bend radius (fixed)	8× outer Ø
Bend radius (moving)	10× outer Ø
Torsion stress	±90°/m
No. of torsion cycles	2 Mio.

Commercial data

country of origin	DE
-------------------	----

customs tariff number	85444290
EAN	4048879644570
eClass	27279218
Packaging unit	1