

M12 male 90° / M12 female 90° B-cod. shielded

PVC 1x2xAWG24 shielded vt UL/CSA 15m

Male 90° – female 90°
M12, 4-pole – M12, 2-pole
B-coded
shielded

Plastic housings with good resistance against chemicals and oils.

The resistance to aggressive media should be individually tested for your application. Further details on request.

Further cable lengths on request.

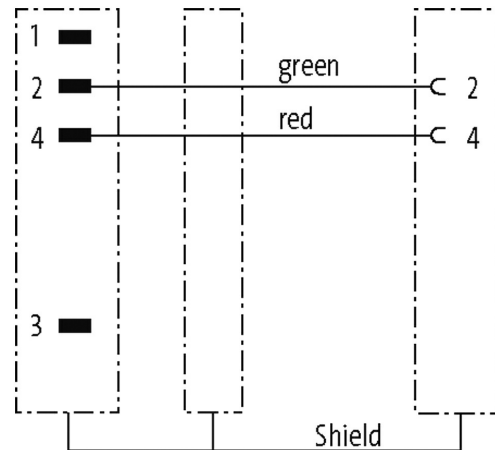
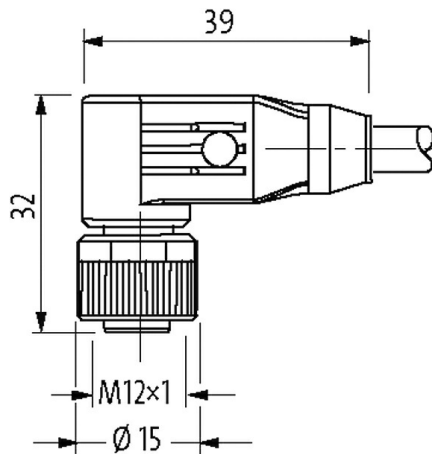
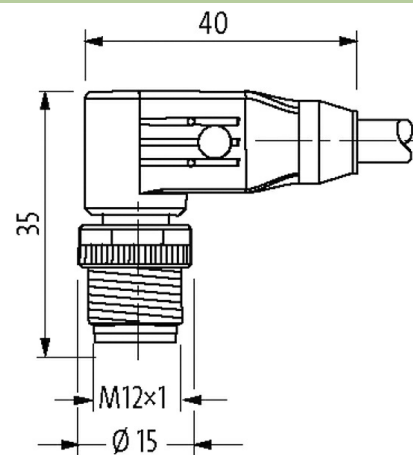
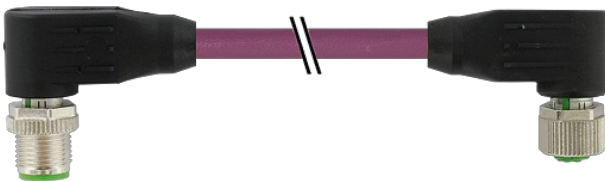
Link to Product**Illustration**

Male

Female

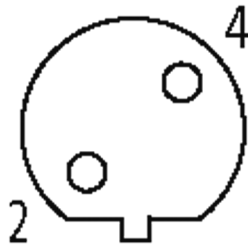

Product may differ from Image



* only for products with UL/CSA approved cable

Form

Form 44021

Technical Data

Operating voltage	max. 60 V AC/DC
Operating voltage (only UL listed)	30 V AC/DC
Rated surge voltage	1.5 kV
Operating current per contact	max. 4 A
No. of poles	M12, 4-pole – M12, 2-pole
Material group	IEC 60664-1, category I
Coding	B-coded
LED display	no
Locking of ports	Screw thread (M12×1 mm) recommended torque 0.6 Nm, self-securing
Compression gland	M12 (SW13)
Protection	IP65, IP66K, IP67 inserted and tightened (EN 60529)
Material	PUR
Locking material	Zinc die casting, matte nickel plated
suitable for corrugated tube (internal Ø)	without

General data

Standards	DIN EN 61076-2-101 (M12)
Mounting method	inserted, tightened
Material (contact)	Copper alloy
Material (contact surface)	Au
Material (gasket)	FKM
Pollution Degree	3
Temperature range	-25...+85 °C, depending on cable quality

Cables

No./diameter of wires	1 × 2 × 0.25 mm ²
Wire isolation	PE (rd, gn)
C-track properties	2 Mio.
Material (jacket)	PVC (UL)
Outer Ø	7.8 mm ±5%
Bend radius (moving)	12 × outer Ø
Temperature range (fixed)	-25...+70 °C
Temperature range (mobile)	-20...+50 °C
Cable identification	850

The information in this brochure has been compiled with the utmost care.

Liability for the correctness completeness and topicality of the information is restricted to gross negligence. Version: 03/22

Cable weight [g/m]	75,90
Material (wire)	Cu wire, bare
Resistor (core)	max. 68 Ω /km (20 °C)
Single wire \varnothing (core)	0.13 mm
Construction (core)	19× 0.13 mm
Diameter (core)	1× 2× 0.25 mm ²
AWG	similar to AWG 24
Material (wire isolation)	PE
Wire- \varnothing incl. isolation	2.55 mm \pm 5%
Color/numbering of wires	rd, gn
Shield	yes
optical shield cover	min. 70%
Material (jacket)	PVC
Outer- \varnothing (jacket)	7.8 mm \pm 5%
Color (jacket)	violet
Nominal voltage	30 V AC
Test voltage	1.5 kV
Temperature range (fixed)	-25...+70 °C
Temperature range (mobile)	-20...+50 °C
Bend radius (fixed)	7.5× outer \varnothing
Bend radius (moving)	12× outer \varnothing
No. of bending cycles (C-track)	max. 2 Mio. (25 °C)
Traversing distance (C-track)	max. 5 m (horizontal)
Travel speed (C-track)	max. 3 m/s
Acceleration (C-track)	max. 5 m/s ²
Jacket Color	violet
Commercial data	
country of origin	DE
customs tariff number	85444290
EAN	4048879526463
eClass	27061801
Packaging unit	1