

M12 Steel male 90° / M12 Steel female 90° A-cod.

TPE-S 4x0.34 gy 1m

F&B-Steel

Male 90° – female 90°

M12 – M12, 4-pole

Further cable lengths on request.

[Link to Product](#)

Illustration

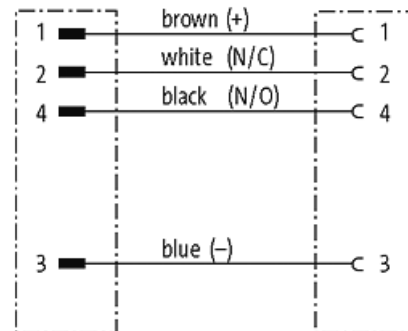
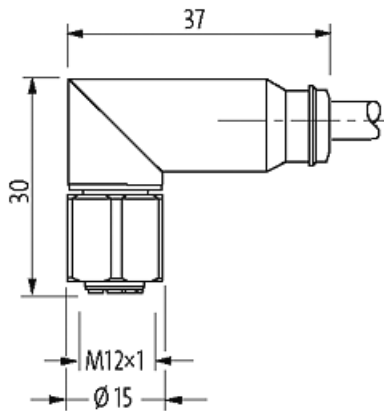
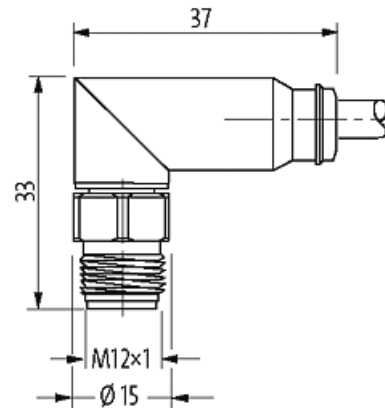
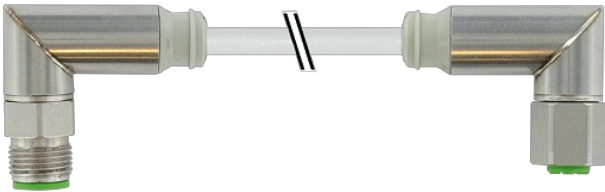

Male

Female

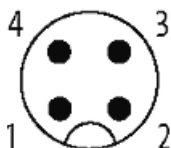

Product may differ from Image



* only for products with UL/CSA approved cable

Form

Form 40261

Technical Data

Operating voltage	max. 32 V AC/DC
Operating current per contact	max. 4 A
Locking of ports	Screw thread (M12×1 mm) recommended torque 0.6 Nm, self-securing
Protection	IP68, IP69K inserted and tightened (EN 60529)
Locking material	Stainless steel 1.4404 (V4A)

General data

Temperature range	-40...+85 °C, depending on cable quality
-------------------	--

Cables

No./diameter of wires	4× 0.34 mm ²
Wire isolation	TPE-S (br, wh, bl, bk)
Material (jacket)	TPE-S
Outer Ø	5.2 mm ±5%
Temperature range (mobile)	-30...+105 °C
Bend radius (moving)	15× outer Ø
Temperature range (fixed)	-50...+125 °C
Cable identification	336
Cable weight [g/m]	43,01
Material (wire)	Cu wire, bare
Resistor (core)	max. 57 Ω/km (20 °C)
Single wire Ø (core)	0.05 mm
Construction (core)	180× 0.05 mm (multi-strand wire class 6)
Diameter (core)	4× 0.34 mm ²
AWG	similar to AWG 22
Material (wire isolation)	TPE-S
Shore hardness (wire isolation)	90 ±5 A
Wire-Ø incl. isolation	1.5 mm ±5%
Color/numbering of wires	br, bk, bl, wh
Stranding combination	4 wires twisted
Shield	no
Material (jacket)	TPE-S
Shore hardness (jacket)	80 ±5 A
Outer-Ø (jacket)	5.2 mm ±5%
Color (jacket)	gray
Test voltage	2500 V AC
Temperature range (fixed)	-50...+125 °C
Temperature range (mobile)	-30...+105 °C
Bend radius (fixed)	10× outer Ø
Bend radius (moving)	15× outer Ø
Jacket Color	gray

Commercial data

country of origin	CZ
customs tariff number	85444290
EAN	4048879580984
eClass	27279218
Packaging unit	1