

Product data sheet

Characteristics

PAS43E0500

portal axis PAS E - toothed belt - ball - payload
25 kg - stroke 500 mm



Main

Range of product	Lexium PAS E
Product or component type	Portal axis
Product specific application	For 1 direction
Load position	On carriage
Drive type	Toothed belt
Guide type	Ball

Complementary

Operating position	Horizontal
Permanent permissible load	25 kg
Distance per revolution	205 mm
Operating force	<= 4410 N for Z axis <= 4410 N for Y axis <= 1100 N for X axis
Maximum actuation speed	2 m/s
Maximum acceleration	15 m/s ²
Torque value	<= 162 N.m for Z axis <= 162 N.m for Y axis <= 42 N.m for X axis <= 36 N.m driving torque
Operating travel	500 mm
Product weight	29.4 kg total 2.1 kg of carriage 18 kg at 0 stroke with carriage and motor
Repeat accuracy	+/- 0.05 mm
Outer dimension	80 x 80 mm
Mechanical service life	30000 km
Associated module	LXM32.D18N4 servo drive (not supplied) PLE80 planetary gearbox, reduction ratio: 5:1 (supplied) BMH1002P06A2A servo motor (supplied)

Offer Sustainability

Sustainable offer status	Not Green Premium product
Product environmental profile	Available  Download Product Environmental
Product end of life instructions	Need no specific recycling operations

The information provided in this documentation contains general descriptions and/or technical characteristics of the performance of the products contained herein. This documentation is not intended as a substitute for and is not to be used for determining suitability or reliability of these products for specific user applications. It is the duty of any such user or integrator to perform the appropriate and complete risk analysis, evaluation and testing of the products with respect to the relevant specific application or use thereof. Neither Schneider Electric Industries SAS nor any of its affiliates or subsidiaries shall be responsible or liable for misuse of the information contained herein.

Size Characteristics

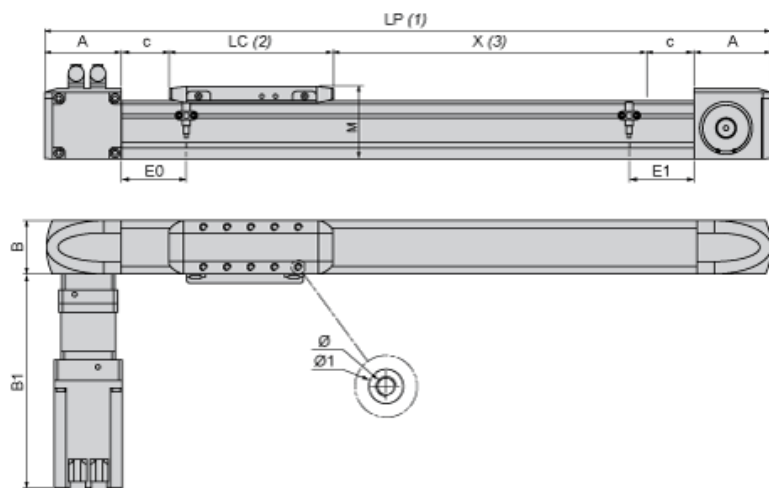

- (1) LP : total length of axis
- (2) LC : length of carriage
- (3) X : Stroke, refer to product characteristics.

A	mm	110
in.	4.33	
B	mm	80
in.	3.15	
B1	mm	322
in.	12.68	
c	mm	25
in.	0.98	
E0	mm	62
in.	2.44	
E1	mm	62
in.	2.44	
LC	mm	244
in.	9.61	
LP	mm	= 270 + LC + X
in.	= 10.63 + LC + X	
M	mm	100
in.	3.94	
Ø	mm	M6 X 14
in.	M6 X 0.55	
Ø1	mm	10 ^{H7} X 2.1
in.	10 ^{H7} X 0.08	

Servo Motor Mounting

Standard servo motor mounting



Servo motor mounted on the left



Axis Positioning Time as a Function of the Stroke

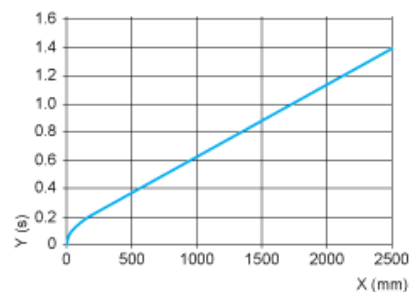

X : Stroke
Y : Positioning time

Forces and Torques Exerted on the Lexium PAS E Portal Axis

