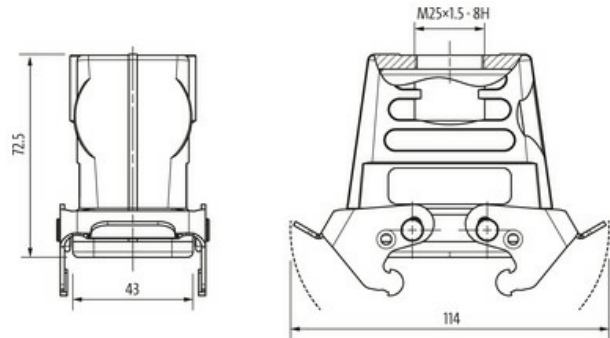

B10 Coupling h., high profile, IP65

Double locking lever m., top entry M25

B10
Coupling housing (high)
Double locking lever
IP65

Technical data will be only guaranteed with Murrelektronik components.

[Link to Product](#)**Illustration**

Product may differ from Image

Technical Data

Mating cycles	min. 500
Locking of ports	Double locking lever
Protection (housing)	IP65 inserted and tightened (EN 60529), with gland

General data

Material (gasket)	NBR
Temperature range	-40...+100 °C
Material (housing)	Aluminum die-cast
Housing type	Coupling housing
Threaded hole	M25
Size	B10
Cable outlet	straight
Locking material	Steel (galvanized)
Climatic category	40/100/21 (EN 60068-1)
Material (housing surface)	powder-coated
Dimensions H×W×D	72.5×43×114 mm

Commercial data

country of origin	CZ
customs tariff number	85389099
EAN	4048879644983
eClass	27143424
Packaging unit	1.000