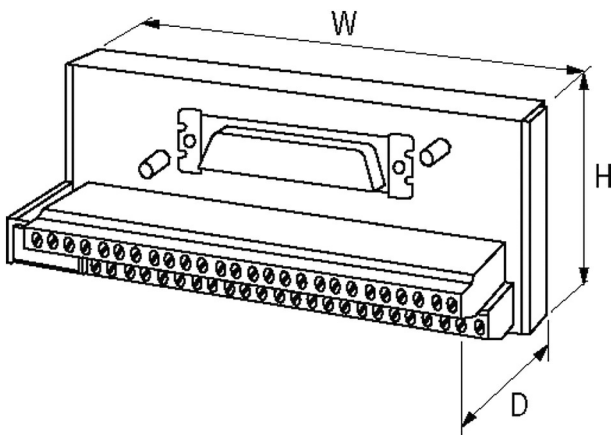
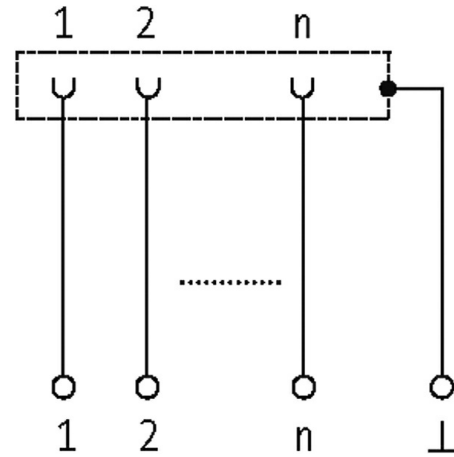

**SV-SUB D 9ST.-KL FOR SIGNAL TRANSFER**

125 VAC/DC / 2 A

Male connector  
9-pole  
Screw terminals

[Link to Product](#)**Illustration**

Product may differ from Image

**Technical Data**

Operating voltage	125 V AC/150 V DC
Material group	EN 60664-1 over voltage, category II
Locking of ports	Standard UNC 4-40 screw thread bolt (EN 60807)
Operating current per bit	max. 2 A

**General data**

Mounting method	DIN-rail mountable (EN 60715)
Temperature range	-20...+70 °C
Dimensions H×W×D	63×50×48 mm

**Commercial data**

country of origin	CZ
customs tariff number	85366990

EAN	4048879026543
eClass	27143424
Packaging unit	1.000