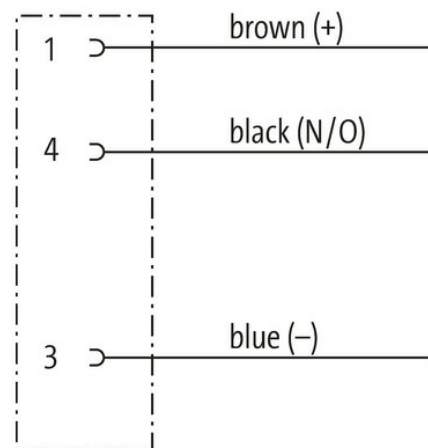

M8 female recept. A-cod. front

PP-wires 3x0.25 0.8m

Flange female
M8, 3-pole
Front mounting
with multi-strand wire

[Link to Product](#)**Illustration**

Female

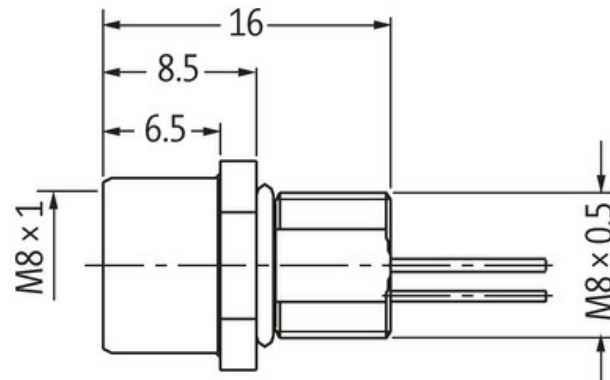
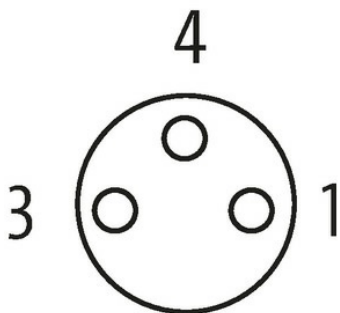

Product may differ from Image

**Form**

Form 08571

Technical Data

Operating voltage	max. 50 V AC/60 V DC
Rated surge voltage	1.5 kV
Operating current per contact	max. 4 A

Material group	IEC 60664-1, category I
Locking of ports	Screw thread (M8×1 mm) recommended torque 0.4 Nm, self-securing
Compression gland	M8 (SW10)
Protection	IP67 inserted and tightened (EN 60529)
Protection NEMA	3, 4, 6P (UL 50E)
Material	Brass, nickel plated
Locking material	Brass, nickel plated

General data

Standards	DIN EN 61076-2-104 (M8)
Material (gasket)	FKM
Pollution Degree	3
Temperature range	-25...+85 °C

Cables

No./diameter of wires	3× 0.25 mm ²
Wire isolation	PP (br, bk, bl)
Outer Ø	1.1 mm ±5%
Cable number	970
Temperature range (fixed)	-40...+90 °C
Temperature range (mobile)	-25...+90 °C
Bend radius (fixed)	5× outer Ø

Commercial data

country of origin	DE
customs tariff number	85444290
EAN	4048879407618
eClass	27279220
Packaging unit	1.000