

CAP FOR D-BOX M12 6-WAY 5-POLE

No pot.-sep. 3m PUR/PVC-JB, 12x0,34+3x0,75

for 6-way distribution boxes, 5-pole

PUR/PVC

3.0 m

Plastic housings with good resistance against chemicals and oils.

The resistance to aggressive media should be individually tested for your application. Further details on request.

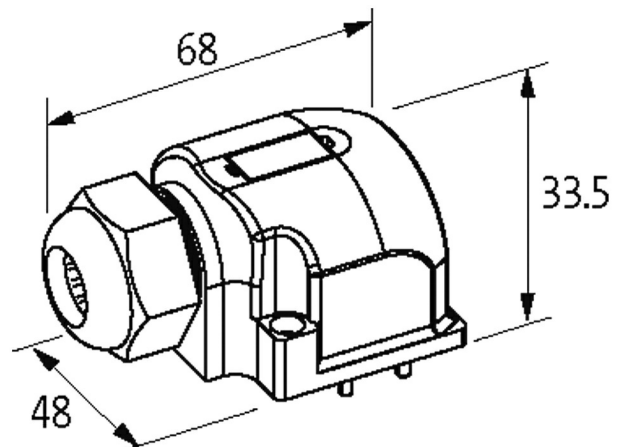
[Link to Product](#)**Illustration**

Product may differ from Image

**Technical Data**

Total current max. 8 A

General data

Dimensions HxWxD 33x48x68 mm

Cables

Cable number 388

No./diameter of wires 12x 0.34 + 3x 0.75 mm²

Wire isolation PVC (yebr, rd, grpk, wh, rdbl, gn, whgn, ye, brgn, gr, whye, pk, br, gnye, bl)

C-track properties 2 Mio.

Jacket Color gray

Material (jacket) PUR/PVC

Outer Ø 9.8 mm ±5%

Bend radius (fixed) 10x outer Ø

Bend radius (moving) 12x outer Ø

Temperature range (fixed) -30...+80 °C

Temperature range (mobile) -5...+70 °C

Color (jacket) gray

Commercial data

country of origin CZ

customs tariff number 85444290

EAN	4048879058377
eClass	27143423
Packaging unit	1