

M12 male 90° B-cod. with cable shielded

PUR 3x2x0.25 shielded vt 5m

Interbus
Male 90°
M12, 5-pole
B-coded
shielded

Further cable lengths on request.

Plastic housings with good resistance against chemicals and oils.

The resistance to aggressive media should be individually tested for your application. Further details on request.

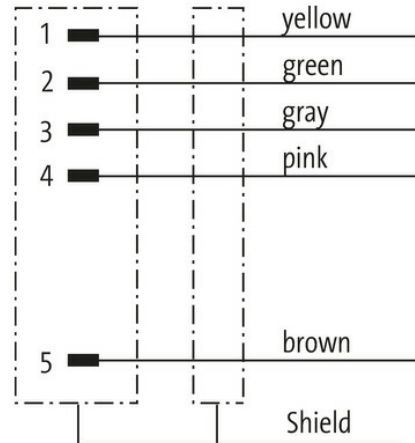
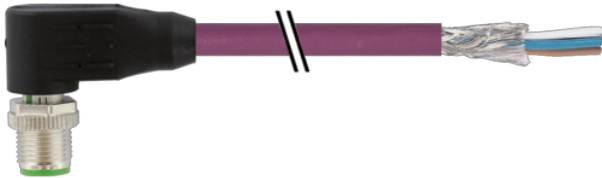
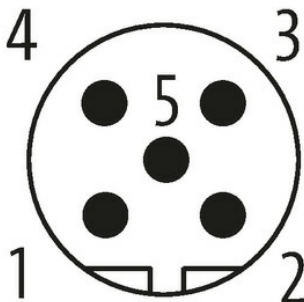
[Link to Product](#)**Illustration****Male**

Product may differ from Image

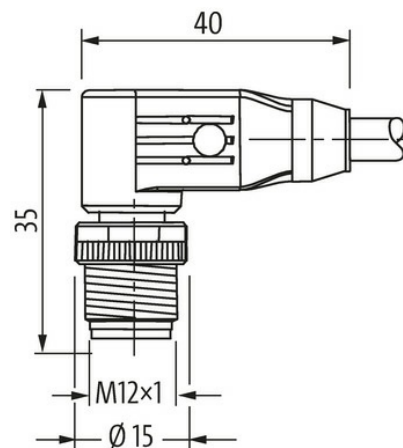
**Form**

Form

14251

Technical Data

The information in this brochure has been compiled with the utmost care.

Liability for the correctness completeness and topicality of the information is restricted to gross negligence. Version: 03/22

Murrelektronik Ltd. | 5 Albion Street, Pendlebury Industrial Estate, Swinton | Manchester M27 4FG | Fon +44 161 728 3133 | Fax +44 161 728 3130 | shop@murrelektronik.co.uk | shop.murrelektronik.co.uk

Operating voltage	max. 60 V AC/DC
Rated surge voltage	1.5 kV
Operating current per contact	max. 4 A
No. of poles	5
Material group	IEC 60664-1, category I
Coding	B-coded
Locking of ports	Screw thread (M12×1 mm) recommended torque 0.6 Nm, self-securing
Compression gland	M12 (SW13)
Protection	IP67 inserted and tightened (EN 60529)
Locking material	Zinc die casting, matte nickel plated

General data

Pollution Degree	3
Temperature range	-25...+85 °C, depending on cable quality

Cables

No./diameter of wires	3× (2× AWG24)
Wire isolation	PE (whbr, grpk, gnye)
C-track properties	2 Mio.
Outer Ø	7.7 mm ±5%
Cable identification	799
Approval (cable)	Interbus (DIN 19258/EN50254/IEC 61158 conform)
Cable weight [g/m]	76,49 g
Material (wire)	Cu wire, bare
Resistor (core)	max. 96 Ω/km (20°C)
Single wire Ø (core)	0.1 mm
Construction (core)	32× 0.1 mm (multi-strand wire class 6)
Diameter (core)	3× (2× AWG24)
AWG	similar to AWG 24
Material (wire isolation)	PE
Shore hardness (wire isolation)	55 ±5 D
Wire-Ø incl. isolation	1.4 mm ±5%
Color/numbering of wires	(wh, br) + (gr, pk) + (gn, ye)
Shield	yes
optical shield cover	min. 85%
Material (jacket)	PUR
Material property (jacket)	CFC-, halogen- and cadmium-free, matt, low-adhesion, machine easy to process, abrasion-resistant
Shore hardness (jacket)	85 ±5 A
Outer-Ø (jacket)	7.7 mm ±5%
Color (jacket)	violet
Jacket Color	violet
chemical resistance	good resistance to oil, gasoline and chemicals (VDE 0472 Teil 803/VDE 0249)
Nominal voltage	250 V AC
Test voltage	1500 V (wire/wire); 1000 V (wire/shield)
Temperature range (fixed)	-40...+70 °C
Temperature range (fixed)	-40...+80 °C
Temperature range (mobile)	-30...+70 °C
Temperature range (mobile)	-30...+70 °C
Bend radius (fixed)	6× outer Ø
Bend radius (moving)	15× outer Ø
Bend radius (moving)	12× outer Ø
No. of bending cycles (C-track)	max. 2 Mio. (25 °C)
Travel speed (C-track)	max. 3 m/s
Acceleration (C-track)	max. 3 m/s ²
Material (jacket)	PUR

Commercial data

country of origin	DE
customs tariff number	85444290
EAN	4048879419116
eClass	27061801
Packaging unit	1.000