

M12 male 0° / M12 female 0° A-cod.

PUR 2x1.5 gy UL/CSA+drag ch. 2m

AS-Interface

Male straight – female straight

M12 – M12, 2-pole

for MASI68

Plastic housings with good resistance against chemicals and oils.

The resistance to aggressive media should be individually tested for your application. Further details on request.

Further cable lengths on request.

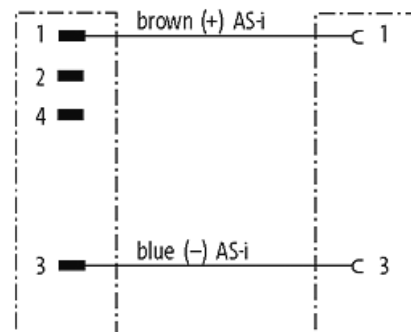
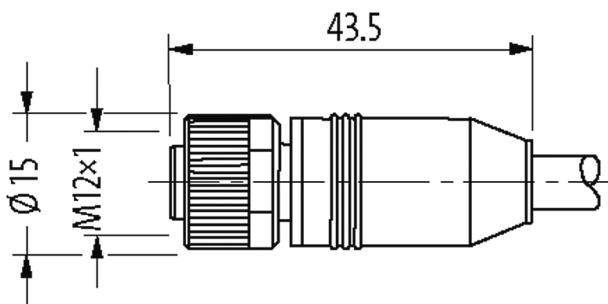
Link to Product**Illustration**

Male

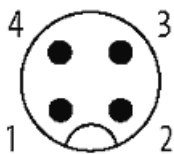

Female

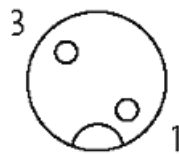

Product may differ from Image



* only for products with UL/CSA approved cable

Form

Form 40005

Technical Data

Operating voltage max. 250 V AC/DC

Operating current per contact	max. 4 A
Locking of ports	Screw thread (M12×1 mm) recommended torque 0.6 Nm, self-securing
Protection	IP67, IP68 inserted and tightened (EN 60529)
Locking material	Zinc die casting, matte nickel plated

General data

Temperature range	-25...+85 °C, depending on cable quality
-------------------	--

Cables

No./diameter of wires	2× 1.5 mm ²
Wire isolation	PP (br, bl)
C-track properties	5 Mio.
Material (jacket)	PUR (UL/CSA)
Outer Ø	8.0 mm ±5%
Bend radius (moving)	15× outer Ø
Temperature range (fixed)	-50...+80 °C
Temperature range (mobile)	-25...+80 °C
Cable identification	588
Approval (cable)	UL (AWM-Style 21198/10493), CSA
Cable weight [g/m]	80,30
Material (wire)	Cu wire, bare
Resistor (core)	max. 13.3 Ω/km (20 °C)
Single wire Ø (core)	0.25 mm
Construction (core)	30× 0.25 mm (multi-strand wire class 5)
Diameter (core)	2× 1.5 mm ²
AWG	similar to AWG 16
Material (wire isolation)	PP
Material property (wire isolation)	CFC-, halogen-, cadmium-, silicone- and lead-free
Shore hardness (wire isolation)	70 ±5 D
Wire-Ø incl. isolation	2.95 mm ±5%
Color/numbering of wires	br, bl
Shield	no
Material (jacket)	PUR
Material property (jacket)	CFC-, halogen-, cadmium-, silicone- and lead-free, matt, low-adhesion, machine easy to process, abrasion-resistant, hydrolysis and microbial resistant
Shore hardness (jacket)	90 ±5 A
Outer-Ø (jacket)	8.0 mm ±5%
Color (jacket)	gray
chemical resistance	good resistance to oil, gasoline and chemicals (VDE 0472 Teil 803 Test B)
thermal resistance	flame retardant UL, CSA FT2 / IEC 60332-2-2
Nominal voltage	300 V AC
Test voltage	2000 V AC
Current load capacity	to DIN VDE 0298-4
Temperature range (fixed)	-50...+80 °C
Temperature range (mobile)	-25...+80 °C (+60 °C, C-track)
Bend radius (fixed)	10× outer Ø
Bend radius (moving)	15× outer Ø
No. of bending cycles (C-track)	max. 5 Mio. (25 °C)
Traversing distance (C-track)	max. 5 m (horizontal)
Travel speed (C-track)	max. 2 m/s
Acceleration (C-track)	max. 5 m/s ²
Jacket Color	gray

Commercial data

country of origin	CZ
customs tariff number	85444290

EAN	4048879283458
eClass	27279218
Packaging unit	1