

M12 male 0° / M12 female 0° A-cod. shielded

PVC 12x0.14 shielded bk 5m

Male straight – female straight
M12 – M12, 12-pole
shielded

Plastic housings with good resistance against chemicals and oils.

The resistance to aggressive media should be individually tested for your application. Further details on request.

Further cable lengths on request.

[Link to Product](#)

Illustration

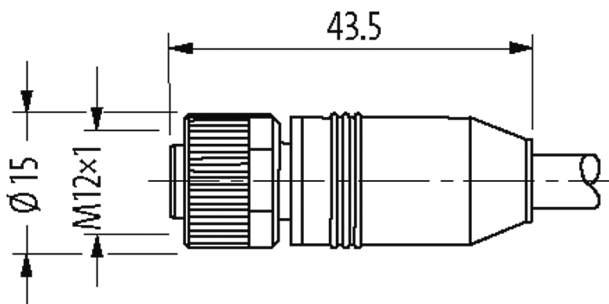
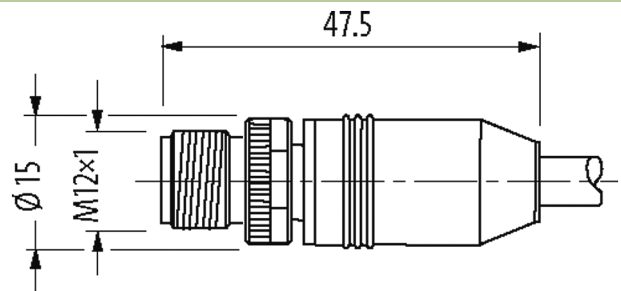

1	■ brown	┌──┐	┌──┐	┌──┐
2	■ blue	┌──┐	┌──┐	┌──┐
3	■ white	┌──┐	┌──┐	┌──┐
4	■ green	┌──┐	┌──┐	┌──┐
5	■ pink	┌──┐	┌──┐	┌──┐
6	■ yellow	┌──┐	┌──┐	┌──┐
7	■ black	┌──┐	┌──┐	┌──┐
8	■ gray	┌──┐	┌──┐	┌──┐
9	■ red	┌──┐	┌──┐	┌──┐
10	■ violet	┌──┐	┌──┐	┌──┐
11	■ gray/pink	┌──┐	┌──┐	┌──┐
12	■ red/blue	┌──┐	┌──┐	┌──┐
				└──┘
				Shield

Male

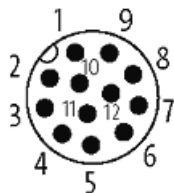

Female

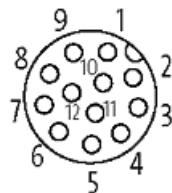

Product may differ from Image

* only for products with UL/CSA approved cable

Form

Form

53301

Technical Data	
Operating voltage	max. 30 V AC/DC
Rated surge voltage	0.8 kV
Operating current per contact	max. 1.5 A
No. of poles	12
Coding	A-coded
LED display	no
Locking of ports	Screw thread (M12×1 mm) recommended torque 0.6 Nm, self-securing
Compression gland	M12 (SW13)
Protection	IP67 inserted and tightened (EN 60529)
Locking material	Zinc die casting, matte nickel plated
Material	PUR
suitable for corrugated tube (internal Ø)	without
General data	
Standards	DIN EN 61076-2-101 (M12)
Mounting method	inserted, tightened
Material (contact)	Copper alloy
Material (contact surface)	Au
Material (gasket)	FKM
Pollution Degree	3
Temperature range	-25...+85 °C, depending on cable quality
Cables	
No./diameter of wires	12× 0.14 mm ²
Wire isolation	PVC (br, bl, wh, gn, pk, ye, bk, gr, rd, vi, grpk, rdbl)
Outer Ø	6.5 mm ±5%
Temperature range (fixed)	-30...+80 °C
Temperature range (mobile)	-5...+80 °C
Cable identification	703
Cable Type	1 (PVC)
Approval (cable)	cURus (AWM-Style 2464/173)
Cable weight [g/m]	73,70
Resistor (core)	max. 138 Ω/km (20 °C)
Material (wire)	Cu wire, bare
Single wire Ø (core)	0.1 mm
Construction (core)	18× 0.1 mm (multi-strand wire class 5)
Diameter (core)	12× 0.14 mm ²
AWG	similar to AWG 26
Material (wire isolation)	PVC
Material property (wire isolation)	CFC-, cadmium-, silicone- and lead-free, matt, low-adhesion, machine easy to process, abrasion-resistant
Shore hardness (wire isolation)	45 ±5 D
Wire-Ø incl. isolation	1.05 mm ±5%
Color/numbering of wires	br, rd, gr, bk, ye, pk, gn, wh, bl, rdbl, grpk, vi
Stranding combination	Twisted wires rdbl, grpk and vi, over it all other wires are twisted
Shield	yes
Material (jacket)	PVC
Material property (jacket)	CFC-, cadmium-, silicone- and lead-free, matt, low-adhesion, machine easy to process, abrasion-resistant
Shore hardness (jacket)	85 ±5 A
Outer-Ø (jacket)	6.5 mm ±5%
Color (jacket)	black
chemical resistance	good resistance to oil, gasoline and chemicals
thermal resistance	flame retardant UL 1581 VW1 / CSA FT1
Nominal voltage	UL 300 V AC
Test voltage	2000 V

The information in this brochure has been compiled with the utmost care.

Liability for the correctness completeness and topicality of the information is restricted to gross negligence. Version: 03/22

Current load capacity	to DIN VDE 0298-4
Temperature range (fixed)	-30...+80 °C
Temperature range (mobile)	-5...+80 °C
Bend radius (fixed)	10× outer Ø
Bend radius (moving)	10× outer Ø
Jacket Color	black
Commercial data	
country of origin	DE
customs tariff number	85444290
EAN	4048879685016
eClass	27279218
Packaging unit	1