

M12 male 0°/ M12 fem. recept. Y-cod. shielded rear

PVC AWG24+22 shielded gn UL/CSA+drag ch. 5m

Male straight – flange female straight

M12 – M12, 8-pole

partly used

shielded

without cable sleeves

Ethernet CAT5

Further cable lengths on request.

Plastic housings with good resistance against chemicals and oils.

The resistance to aggressive media should be individually tested for your application. Further details on request.

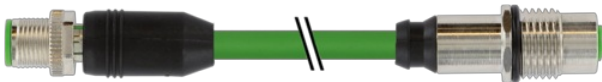
[Link to Product](#)**Illustration**

Male

Female

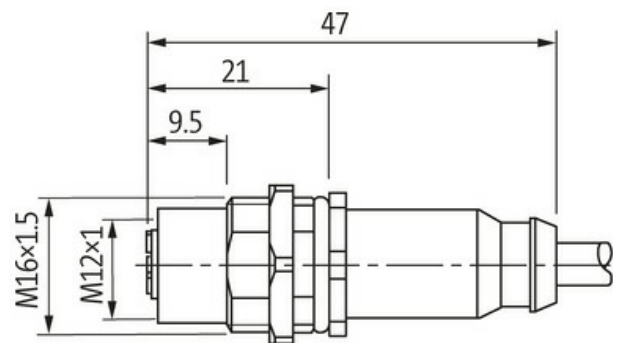
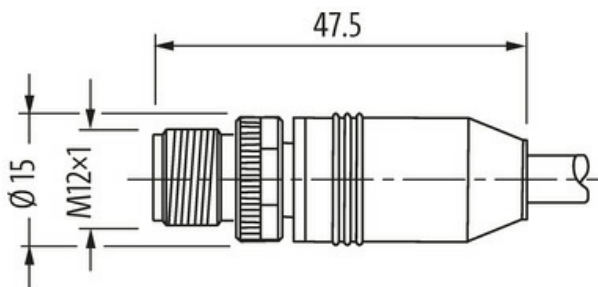
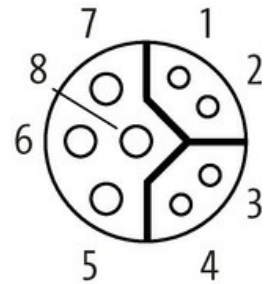
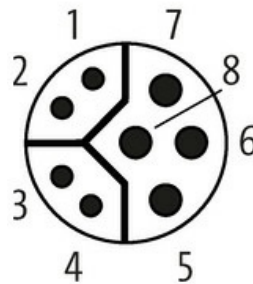

Product may differ from Image



Form

Form SS615

Technical Data

Operating voltage	max. 30 V AC/DC
Rated surge voltage	0.8 kV
Operating current per contact	0.5 A (Data), 6 A (Power)

Transfer parameters	CAT5, Class D (ISO/IEC 11801:2002), (EN 50173-1)
Transfer rate	up to 100 Mbit/s full duplex
Material group	IEC 60664-1, category I
Coding	Y-coded
Locking of ports	Screw thread (M12×1 mm) recommended torque 0.6 Nm, self-securing, nut (M16×1.5 mm)
Compression gland	M12 (SW13), flange (SW19)
Protection	IP67 inserted and tightened (EN 60529)
Protection NEMA	3, 4, 6P (UL 50E)
Material	PUR
Locking material	Zinc die casting, matte nickel plated
suitable for corrugated tube (internal Ø)	without

General data

Material (gasket)	FKM
Pollution Degree	3
Temperature range	-25...+85 °C, depending on cable quality

Cables

No./diameter of wires	2× 2× AWG24 + 1× 2× AWG22
Wire isolation	PE (gnye, pkbl, rdbk)
C-track properties	0.1 Mio.
Outer Ø	6.9 mm ±5%
Cable number	881
Shield	yes
Jacket Color	green
Temperature range (fixed)	-20...+70 °C
Temperature range (mobile)	-5...+70 °C
Bend radius (fixed)	5× outer Ø
Bend radius (moving)	20× outer Ø
Torsion stress	±30°/m
Material (jacket)	PVC (UL/CSA)

Commercial data

country of origin	DE
customs tariff number	85444290
EAN	4048879618458
Packaging unit	1.000