

M12 female 90° A-cod. with cable

PVC 3x0.75 gy 5m

Female 90°

M12, 3-pole

2x LED (PNP)

Invers-polarity protection

Plastic housings with good resistance against chemicals and oils.

The resistance to aggressive media should be individually tested for your application. Further details on request.

Further cable lengths on request.

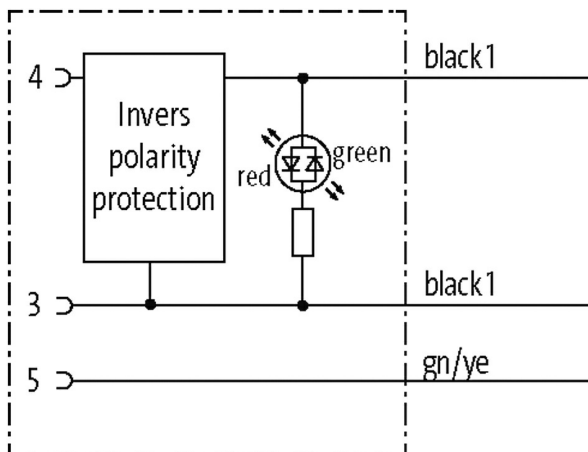
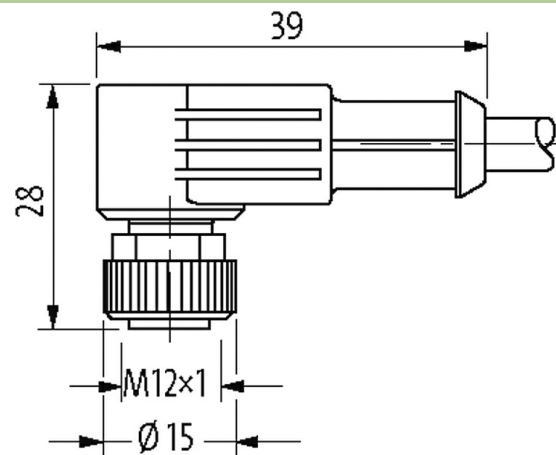
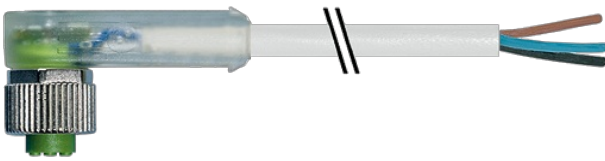
Link to Product**Illustration**

Female



Product may differ from Image

* only for products with UL/CSA approved cable

Form

Form 13701

Technical DataOperating voltage 24 V DC $\pm 15\%$

Rated surge voltage	0.8 kV
Operating current per contact	max. 4 A
Coding	A-coded
LED display	LED (red/green)
Locking of ports	Screw thread (M12×1 mm) recommended torque 0.6 Nm, self-securing
Compression gland	M12 (SW13)
Protection	IP65 and IP67 when plugged and screwed down (EN 60529)
Locking material	Zinc die casting, matte nickel plated
Material	PUR
suitable for corrugated tube (internal Ø)	10

General data

Pollution Degree	3
Temperature range	-25...+85 °C, depending on cable quality

Cables

No./diameter of wires	3× 0.75 mm ²
Wire isolation	PVC (bk num, gnye)
Material (jacket)	PVC
Outer Ø	5.9 mm ±5%
Bend radius (moving)	10× outer Ø
Temperature range (fixed)	-30...+70 °C
Temperature range (mobile)	-5...+70 °C
Cable identification	216
Cable Type	1 (PVC)
Approval (cable)	CE conform
Cable weight [g/m]	63,80
Material (wire)	Cu wire, bare
Resistor (core)	max. 26 Ω/km (20 °C)
Single wire Ø (core)	0.2 mm
Construction (core)	24× 0.2 mm (multi-strand wire class 5)
Diameter (core)	3× 0.75 mm ²
AWG	similar to AWG 18
Material (wire isolation)	PVC
Material property (wire isolation)	CFC-, cadmium-, silicone- and lead-free
Shore hardness (wire isolation)	43 ±5 D
Wire-Ø incl. isolation	1.8 mm ±5%
Color/numbering of wires	bk numbered, gnye longitudinally striped
Stranding combination	3 wires twisted
Shield	no
Material (jacket)	PVC
Material property (jacket)	CFC-, cadmium-, silicone- and lead-free
Shore hardness (jacket)	80 ±5 A
Outer-Ø (jacket)	5.9 mm ±5%
Color (jacket)	gray
chemical resistance	good resistance to oil, gasoline and chemicals
Nominal voltage	300/500 V AC
Test voltage	3000 V AC
Current load capacity	to DIN VDE 0298-4
Temperature range (fixed)	-30...+70 °C
Temperature range (mobile)	-5...+70 °C
Bend radius (fixed)	5× outer Ø
Bend radius (moving)	10× outer Ø
Jacket Color	gray

Commercial data

The information in this brochure has been compiled with the utmost care.

Liability for the correctness completeness and topicality of the information is restricted to gross negligence. Version: 03/22

country of origin	DE
customs tariff number	85444290
EAN	4048879462051
eClass	27279218
Packaging unit	1