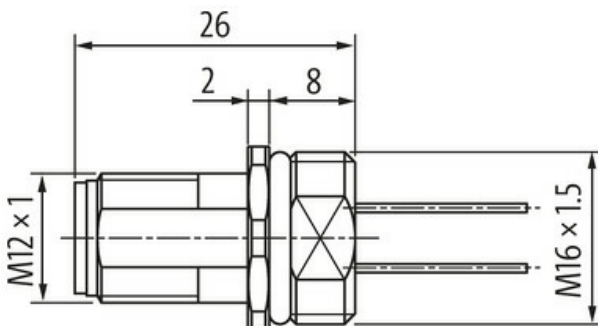
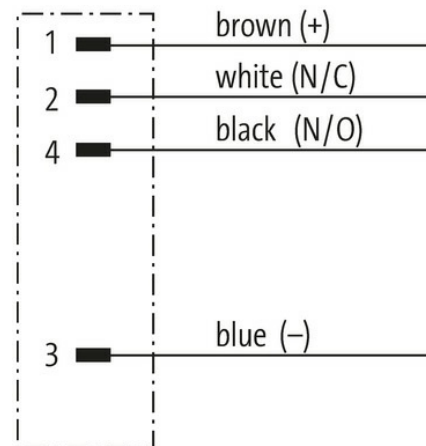

M12 male recept. A-cod. front

PVC-wires 4x0.34 0.5m

Flange male
M12, 4-pole
Front mounting
with multi-strand wire

[Link to Product](#)**Illustration**

Male

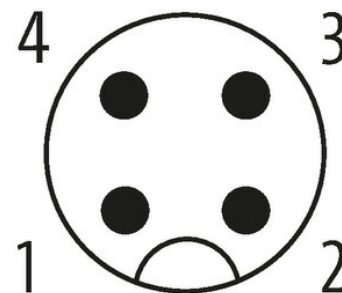

Product may differ from Image

**Form**

Form 13501

Technical Data

Operating voltage	max. 250 V AC/DC
Rated surge voltage	2.5 kV
Operating current per contact	max. 4 A

Material group	IEC 60664-1, category I
Locking of ports	Screw thread (M12×1 mm) recommended torque 0.6 Nm, self-securing
Compression gland	M12 (SW14)
Protection	IP67 inserted and tightened (EN 60529)
Locking material	Zinc die casting, matte nickel plated

General data

Pollution Degree	3
Temperature range	-25...+85 °C

Cables

No./diameter of wires	4× 0.34 mm ²
Wire isolation	PVC (br, wh, bl, bk)
Outer Ø	1.3 mm ±5%
Cable number	901
Temperature range (fixed)	-40...+105 °C
Temperature range (mobile)	-5...+105 °C
Bend radius (fixed)	5× outer Ø

Commercial data

country of origin	DE
customs tariff number	85444290
EAN	4048879294607
eClass	27279220
Packaging unit	1.000