

VALVE PLUG SUPPRESSOR FORM A - 18MM

RC and LED, 24VAC/DC/10VA/W

24 V AC/DC

RC + LED

Remove plug gasket when fitting adapter. Other LED colors on request.

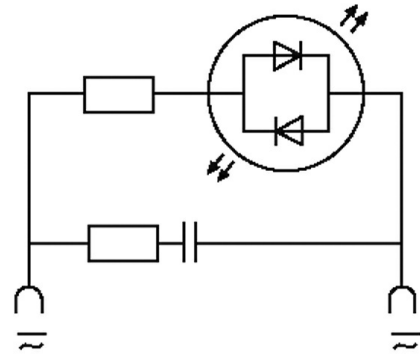
[Link to Product](#)**Illustration**

LED + RC

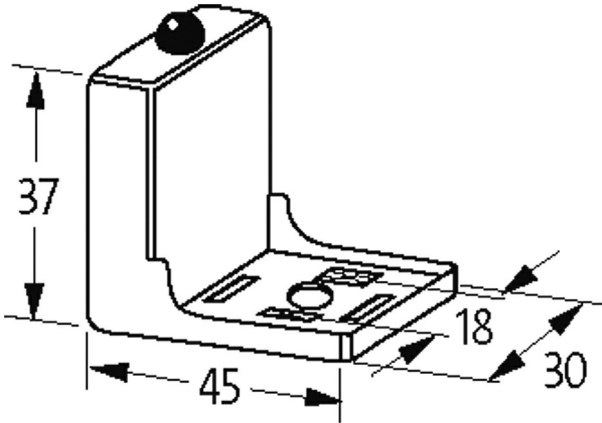

Product may differ from Image

Technical Data

Switch off peak	max. 105 V
LED display	(yellow opac)
Input voltage	12...30 V AC/DC
max. power (W)	max. 10 W (VA)
Switch off delay time	max. 20 ms

General data

Material (contact)	Silvered bronze
Temperature range	-20...+60 °C
Housing	Polyamide black, flame retardant, temperature resistance up to 130 °C
Dimensions H×W×D	37×45×30 mm

Commercial data

country of origin	CZ
-------------------	----

customs tariff number	85363010
EAN	4048879012157
eClass	27371013
Packaging unit	1.000