

M12 male 90° / M12 female 90° A-cod.

PUR 2x0.5 gy UL/CSA+drag ch. 3m

Cube67

Male 90° – female 90°

M12 – M12, 6-pole

2-pole used

Actuator supply external

Plastic housings with good resistance against chemicals and oils.

The resistance to aggressive media should be individually tested for your application. Further details on request.

Further cable lengths on request.

[Link to Product](#)

Illustration

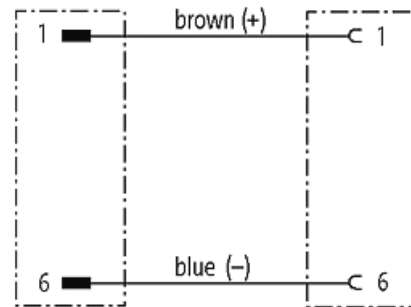
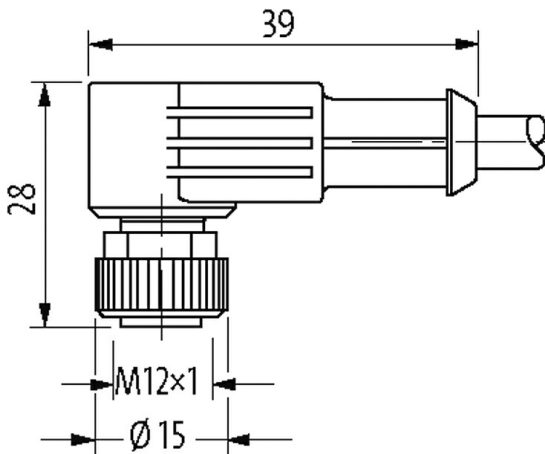
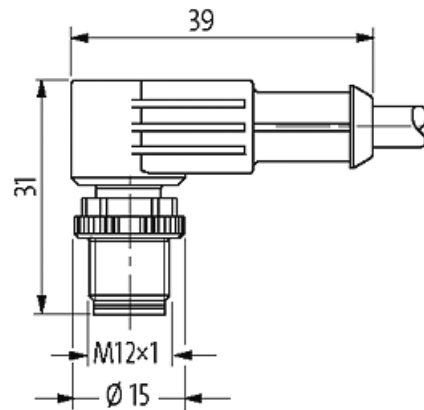
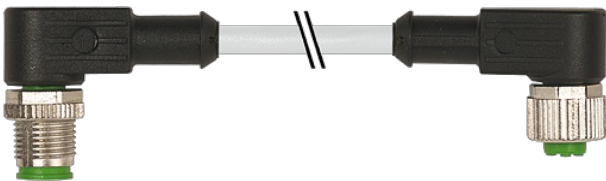

Male

Female

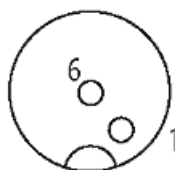
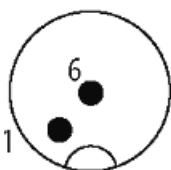

Product may differ from Image



* only for products with UL/CSA approved cable

Form	
Form	46021
Technical Data	
Operating voltage	max. 125 V AC/DC
Operating current per contact	max. 4 A
Locking of ports	Screw thread (M12×1 mm) recommended torque 0.6 Nm, self-securing
Protection	IP66K, IP67 inserted and tightened (EN 60529)
Rated surge voltage	0.8 kV
General data	
Temperature range	-25...+85 °C, depending on cable quality
Cables	
No./diameter of wires	2× 0.5 mm ²
Wire isolation	PP (br, bl)
C-track properties	10 Mio.
Material (jacket)	PUR (UL/CSA)
Outer Ø	4.4 mm ±5%
Bend radius (moving)	10× outer Ø
Temperature range (fixed)	-40...+80 °C
Temperature range (mobile)	-25...+80 °C
Cable identification	414
Cable Type	3 (PUR)
Approval (cable)	cURus (AWM-Style 20549/10493); CE conform
Cable weight [g/m]	30,80
Material (wire)	Cu wire, bare
Resistor (core)	max. 39 Ω/km (20 °C)
Single wire Ø (core)	0.19 mm
Construction (core)	19× 0.18 mm
Diameter (core)	2× 0.5 mm ²
AWG	similar to AWG 20
Material (wire isolation)	PP
Material property (wire isolation)	CFC-, halogen-, cadmium-, silicone- and lead-free
Shore hardness (wire isolation)	70 ±5 D
Wire-Ø incl. isolation	1.4 mm ±5%
Color/numbering of wires	br, bl
Stranding combination	2 wires twisted
Shield	no
Material (jacket)	PUR
Material property (jacket)	CFC-, halogen-, cadmium-, silicone- and lead-free, matt, low-adhesion, machine easy to process, abrasion-resistant, hydrolysis and microbial resistant
Shore hardness (jacket)	90 ±5 A
Outer-Ø (jacket)	4.4 mm ±5%
Color (jacket)	gray
chemical resistance	good resistance to oil, gasoline and chemicals (EN 60811-404)
thermal resistance	flame retardand UL 1581 Section 1090 (H), CSA FT2 / IEC 60332-2-2
Nominal voltage	300 V AC
Test voltage	2500 V AC
Current load capacity	to DIN VDE 0298-4
Temperature range (fixed)	-40...+80 °C, (+90 °C at max. 10 000 operating hours)

The information in this brochure has been compiled with the utmost care.

Liability for the correctness completeness and topicality of the information is restricted to gross negligence. Version: 03/22

Temperature range (mobile)	-25...+80 °C, (+90 °C at max. 10 000 operating hours)
Bend radius (fixed)	5× outer Ø
Bend radius (moving)	10× outer Ø
No. of bending cycles (C-track)	max. 10 Mio. (25 °C)
Travel speed (C-track)	max. 3 m/s
Acceleration (C-track)	max. 10 m/s ²
Torsion stress	±180°/m
No. of torsion cycles	max. 2 Mio. (25 °C)
Torsion speed	35 cycles/min
Jacket Color	gray

Commercial data

country of origin	DE
customs tariff number	85444290
EAN	4048879140621
eClass	27061801
Packaging unit	1