

M12 male 90° / M12 female 90° A-cod.

PUR 8x0.25 gy UL/CSA+drag ch. 0.3m

Male 90° – female 90°

M12 – M12, 8-pole

with cable sleeves

Art-No. 7005 - M12 Lite - (plastic hexagonal screw) on request

Plastic housings with good resistance against chemicals and oils.

The resistance to aggressive media should be individually tested for your application. Further details on request.

Further cable lengths on request.

[Link to Product](#)**Illustration**

1	white	C 1
2	brown	C 2
3	green	C 3
4	yellow	C 4
5	gray	C 5
6	pink	C 6
7	blue	C 7
8	red	C 8

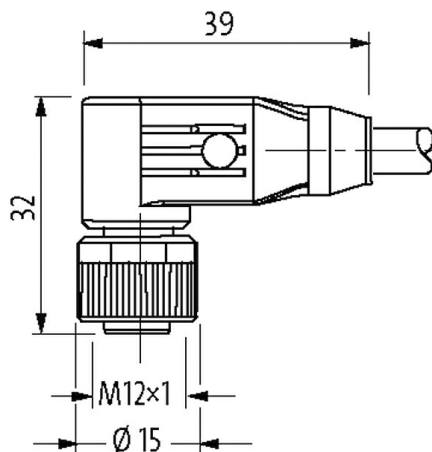



Product may differ from Image



* only for products with UL/CSA approved cable

Form

Form 48021

Technical Data

Operating voltage	max. 30 V AC/DC
Operating voltage (only UL listed)	max. 30 V AC/DC
Rated surge voltage	0.8 kV
Operating current per contact	max. 2 A
Material group	IEC 60664-1, category I
Coding	A-coded
Locking of ports	Screw thread (M12x1 mm) recommended torque 0.6 Nm, self-securing
Compression gland	M12 (SW13)
Protection	IP65, IP66K, IP67 inserted and tightened (EN 60529)
Locking material	Zinc die casting, matte nickel plated
Material	PUR
suitable for corrugated tube (internal Ø)	without

General data

Standards	DIN EN 61076-2-101 (M12)
Pollution Degree	3
Temperature range	-25...+85 °C, depending on cable quality

Cables

No./diameter of wires	8x 0.25 mm ²
Wire isolation	PP (wh, br, gn, ye, gr, pk, bl, rd)
C-track properties	10 Mio.
Material (jacket)	PUR (UL/CSA)
Outer Ø	5.8 mm ±5%
Bend radius (moving)	10x outer Ø
Temperature range (fixed)	-40...+80 °C
Temperature range (mobile)	-25...+80 °C
Cable identification	292
Cable Type	3 (PUR)
Approval (cable)	cURus (AWM-Style 20549/10493); CE conform
Cable weight [g/m]	52,80
Material (wire)	Cu wire, bare

The information in this brochure has been compiled with the utmost care.

Liability for the correctness completeness and topicality of the information is restricted to gross negligence. Version: 03/22

Murrelektronik Ltd. | 5 Albion Street, Pendlebury Industrial Estate, Swinton | Manchester M27 4FG | Fon +44 161 728 3133 | Fax +44 161 728 3130 | shop@murrelektronik.co.uk | shop.murrelektronik.co.uk

Resistor (core)	max. 79 Ω /km (20 °C)
Single wire \varnothing (core)	0.1 mm
Construction (core)	32x 0.1 mm (multi-strand wire class 6)
Diameter (core)	8x 0.25 mm ²
AWG	similar to AWG 24
Material (wire isolation)	PP
Material property (wire isolation)	CFC-, halogen-, cadmium-, silicone- and lead-free
Shore hardness (wire isolation)	70 \pm 5 D
Wire- \varnothing incl. isolation	1.2 mm \pm 5%
Color/numbering of wires	br, wh, rd, bl, pk, gr, ye, gn
Stranding combination	8 wires twisted around central filler
Shield	no
Material (jacket)	PUR
Material property (jacket)	CFC-, halogen-, cadmium-, silicone- and lead-free, matt, low-adhesion, machine easy to process, abrasion-resistant, hydrolysis and microbial resistant
Shore hardness (jacket)	90 \pm 5 A
Outer- \varnothing (jacket)	5.8 mm \pm 5%
Color (jacket)	gray
chemical resistance	good resistance to oil, gasoline and chemicals (EN 60811-404)
thermal resistance	flame retardand UL 1581 Section 1090 (H), CSA FT2 / IEC 60332-2-2
Nominal voltage	300 V AC
Test voltage	2500 V AC
Current load capacity	to DIN VDE 0298-4
Temperature range (fixed)	-40...+80 °C, (+90 °C at max. 10 000 operating hours)
Temperature range (mobile)	-25...+80 °C, (+90 °C at max. 10 000 operating hours)
Bend radius (fixed)	5x outer \varnothing
Bend radius (moving)	10x outer \varnothing
No. of bending cycles (C-track)	max. 10 Mio. (25 °C)
Travel speed (C-track)	max. 3 m/s
Acceleration (C-track)	max. 10 m/s ²
Torsion stress	\pm 180°/m
No. of torsion cycles	max. 2 Mio. (25 °C)
Torsion speed	35 cycles/min
Jacket Color	gray

Commercial data

country of origin	DE
customs tariff number	85444290
EAN	4048879139601
eClass	27279218
Packaging unit	1