

M8 female 0° SnapIn with cable

PUR 5x0.25 bk UL 5m

Female straight

Snap In

M8, 5-pole

B-coded

with cable sleeves

Plastic housings with good resistance against chemicals and oils.

The resistance to aggressive media should be individually tested for your application. Further details on request.

Further cable lengths on request.

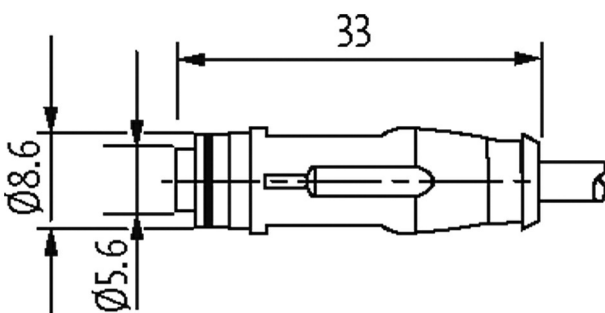
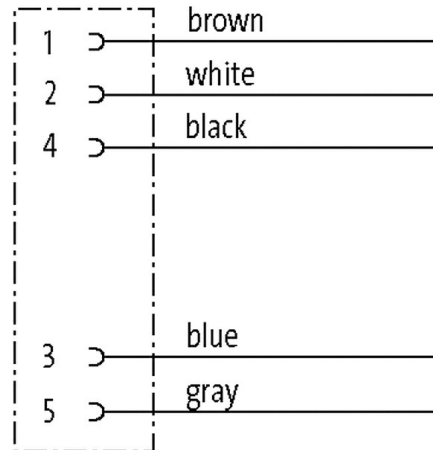
Link to Product**Illustration**

Female

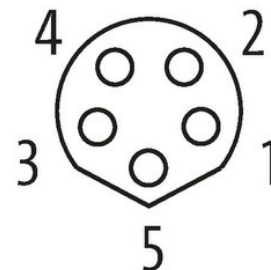

Product may differ from Image

**Form**

Form

08945

Technical Data

The information in this brochure has been compiled with the utmost care.

Liability for the correctness completeness and topicality of the information is restricted to gross negligence. Version: 03/22

Murrelektronik Ltd. | 5 Albion Street, Pendlebury Industrial Estate, Swinton | Manchester M27 4FG | Fon +44 161 728 3133 | Fax +44 161 728 3130 | shop@murrelektronik.co.uk | shop.murrelektronik.co.uk

Operating voltage	max. 30 V AC/DC
Operating current per contact	max. 3 A
No. of poles	5
Coding	B-coded
Mating cycles	≥ 100
LED display	no
Locking of ports	Snap-in connector
Compression gland	M8 Snap In
Protection	IP67
Material	TPU

General data

Mounting method	inserted
Material (contact)	Copper alloy
Pollution Degree	3/2
Temperature range	-30...+80 °C

Cables

Cable identification	695
Material (wire)	Cu wire, bare
Resistor (core)	max. 58 Ω/km (20 °C)
Single wire Ø (core)	0.1 mm
Construction (core)	32× 0.1 mm (multi-strand wire class 6)
Diameter (core)	5× 0.25 mm ²
AWG	similar to AWG 24
Material (wire isolation)	PP
Wire-Ø incl. isolation	1.2 mm ±5%
Stranding combination	5 wires twisted around central filler
Shield	no
Material (jacket)	PUR
Outer-Ø (jacket)	4.7 mm ±5%
Color (jacket)	black
Nominal voltage	300 V
Test voltage	3000 V AC
Temperature range (fixed)	-25...+80 °C
Temperature range (mobile)	-10...+80 °C
Bend radius (moving)	7.5× outer Ø
No. of bending cycles (C-track)	max. 5 Mio. (25 °C)
Travel speed (C-track)	max. 3 m/s
Acceleration (C-track)	max. 5 m/s ²

Commercial data

country of origin	CZ
customs tariff number	85444290
EAN	4048879779401
eClass	27279218
Packaging unit	1.000