

**M12 female recept. A-cod. front incl. nut**

TPE-wires 12x0.14 0.2m

Flange female  
M12, 12-pole  
Front mounting  
with multi-strand wire

[Link to Product](#)

**Illustration**



1	↷	brown
2	↷	blue
3	↷	white
4	↷	green
5	↷	pink
6	↷	yellow
7	↷	black
8	↷	gray
9	↷	red
10	↷	violet
11	↷	gray/pink
12	↷	red/blue

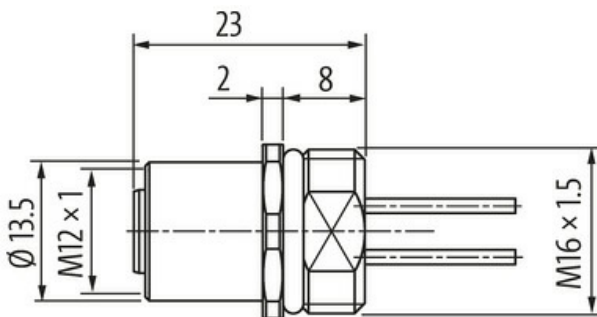

**Female**

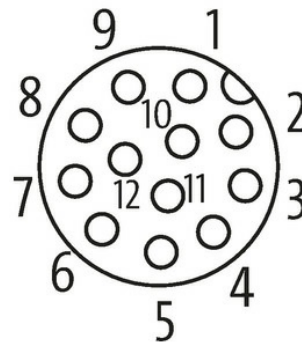

Product may differ from Image



**Form**

Form 19182

**Technical Data**

Operating voltage	max. 30 V AC/DC
Rated surge voltage	0.8 kV
Operating current per contact	max. 1.5 A

No. of poles	12
Material group	IEC 60664-1, category I
Coding	A-coded
LED display	no
Locking of ports	Screw thread (M12×1 mm) recommended torque 0.6 Nm, self-securing
Compression gland	M12 (SW14)
Protection	IP67 inserted and tightened (EN 60529)
Protection NEMA	3, 4, 6P (UL 50E)
Locking material	Zinc die casting, matte nickel plated

#### General data

Material (contact)	Copper alloy
Material (contact surface)	Au
Material (gasket)	FKM
Pollution Degree	3
Temperature range	-25...+85 °C, depending on cable quality

#### Cables

No./diameter of wires	12× 0.14 mm <sup>2</sup>
Wire isolation	PP (br, bl, wh, gn, pk, ye, bk, gr, rd, vi, grpk, rdbl)
Outer Ø	1.25 mm ±5%
Cable number	979
Temperature range (fixed)	-40...+85 °C
Temperature range (mobile)	-25...+85 °C
Bend radius (fixed)	5× outer Ø
Bend radius (moving)	15× outer Ø

#### Commercial data

country of origin	DE
customs tariff number	85444290
EAN	4048879553643
eClass	27279220
Packaging unit	1.000