

M12 male 90° A-cod. / MSUD valve plug A-18mm

PUR 3x0.75 bk UL/CSA+drag ch. 1m

Form A (18 mm) – M12, male 90°

24 V AC $\pm 20\%$ / DC $\pm 25\%$

LED and suppression

Bridged PE

Art-No. 7005 - M12 Lite - (plastic hexagonal screw) on request

Further cable lengths on request.

Plastic housings with good resistance against chemicals and oils.

The resistance to aggressive media should be individually tested for your application. Further details on request.

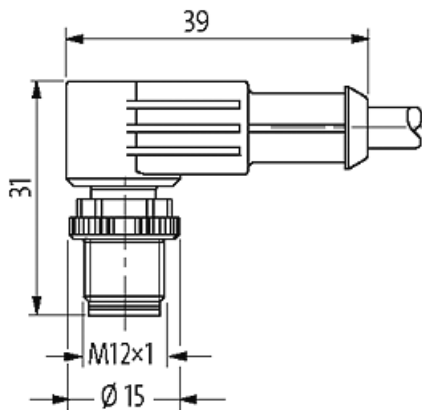
[Link to Product](#)**Illustration**

Female



Male



Product may differ from Image



Form	
Form	40901
Technical Data	
Operating voltage	24 V AC $\pm 20\%$ / DC $\pm 25\%$
Rated surge voltage	0.8 kV
Operating current per contact	max. 4 A
Current consumption	approx. 15 mA
Material group	IEC 60664-1, category I
Switch off peak	max. 55 V
Switch off delay time	max. 20 ms
Coding	A-coded
LED display	yellow
Locking of ports	M3/M12 \times 1 mm (recommended torque 0.4/0.6 Nm)
Compression gland	M12 (SW13)
Protection	IP67 inserted and tightened (EN 60529)
Locking material	Zinc die casting, matte nickel plated
Material	MSUD (PBT); M12 (PUR)
suitable for corrugated tube (internal \varnothing)	10 mm
Housing	Black plastic (gray on request)
Additional suppressor	Diode/Z-Diode
General data	
Pollution Degree	3
Temperature range	-25...+85 °C, depending on cable quality
Material (gasket)	PUR
Cables	
No./diameter of wires	3 \times 0.75 mm ²
Wire isolation	PP (bk num, gnye)
C-track properties	10 Mio.
Material (jacket)	PUR (UL/CSA)
Outer \varnothing	5.9 mm $\pm 5\%$
Bend radius (moving)	10 \times outer \varnothing
Temperature range (fixed)	-40...+80 °C
Temperature range (mobile)	-25...+80 °C
Cable identification	636
Cable Type	3 (PUR)
Approval (cable)	cURus (AWM-Style 20549/10493); CE conform
Cable weight [g/m]	56,10
Material (wire)	Cu wire, bare
Resistor (core)	max. 26 Ω /km (20 °C)
Single wire \varnothing (core)	0.15 mm
Construction (core)	42 \times 0.15 mm (multi-strand wire class 6)
Diameter (core)	3 \times 0.75 mm ²
AWG	similar to AWG 18
Material (wire isolation)	PP
Material property (wire isolation)	CFC-, halogen-, cadmium-, silicone- and lead-free
Shore hardness (wire isolation)	70 ± 5 D
Wire- \varnothing incl. isolation	1.85 mm $\pm 5\%$

Color/numbering of wires	bk numbered, gnye longitudinally striped
Stranding combination	3 wires twisted
Shield	no
Material (jacket)	PUR
Material property (jacket)	CFC-, halogen-, cadmium-, silicone- and lead-free, matt, low-adhesion, machine easy to process, abrasion-resistant, hydrolysis and microbial resistant
Shore hardness (jacket)	90 ±5 A
Outer-Ø (jacket)	5.9 mm ±5%
Color (jacket)	black
chemical resistance	good resistance to oil, gasoline and chemicals (EN 60811-404)
thermal resistance	flame retardand UL 1581 Section 1090 (H), CSA FT2 / IEC 60332-2-2
Nominal voltage	300 V AC
Test voltage	2500 V AC
Current load capacity	to DIN VDE 0298-4
Temperature range (fixed)	-40...+80 °C, (+90 °C at max. 10 000 operating hours)
Temperature range (mobile)	-25...+80 °C, (+90 °C at max. 10 000 operating hours)
Bend radius (fixed)	5× outer Ø
Bend radius (moving)	10× outer Ø
No. of bending cycles (C-track)	max. 10 Mio. (25 °C)
Travel speed (C-track)	max. 3 m/s
Acceleration (C-track)	max. 10 m/s ²
Torsion stress	±180°/m
No. of torsion cycles	max. 2 Mio. (25 °C)
Torsion speed	35 cycles/min
Jacket Color	black

Commercial data

country of origin	CZ
customs tariff number	85444290
EAN	4048879151092
eClass	27279218
Packaging unit	1