

CAP FOR D-BOX M12 4-WAY 5-POLE

No pot.-sep. 3m PUR, 8x0,5+3x1,0

for 4-way distribution boxes, 5-pole

Further cable lengths on request.

Plastic housings with good resistance against chemicals and oils.

The resistance to aggressive media should be individually tested for your application. Further details on request.

3.0 m

[Link to Product](#)

Illustration

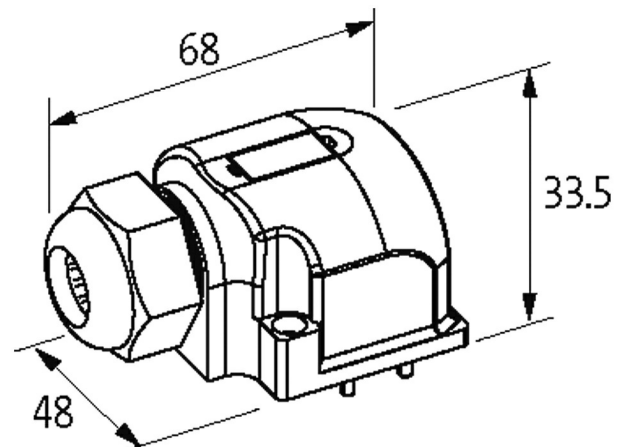

M12-Females 5-pole

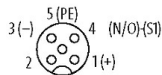

Exact12

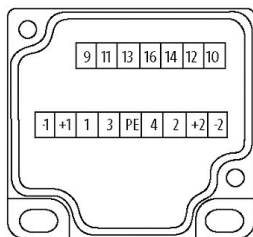

for 2 signals per port

Product may differ from Image

Technical Data

Housing	Plastic, flame retardant
Total current	max. 8 A

General data

Temperature range	-20...+80 °C, depending on cable quality
-------------------	--

Cables

Cable number	448
No./diameter of wires	8× 0.5 + 3× 1.0 mm ²
Wire isolation	TPE (grpk, wh, rdbl, gn, whgn, ye, brgn, gr, br, bl, gnye)
C-track properties	5 Mio.

Jacket Color	gray
Material (jacket)	PUR (UL/CSA)
Outer Ø	9.1 mm ±5%
Bend radius (moving)	10× outer Ø
Temperature range (fixed)	-40...+90 °C
Temperature range (mobile)	-40...+90 °C
Material (wire)	Cu wire, bare
Construction (core)	64× 0.1 mm (0.5 mm ²), 128× 0.1 mm (1.0 mm ²); (multi-strand wire class 6)
Bend radius (fixed)	5× outer Ø
Approval (cable)	UL (AWM-Style 20233), CSA

Commercial data

country of origin	CZ
customs tariff number	85444290
EAN	4048879055536
eClass	27143423
Packaging unit	1