

MSDD PASS-THROUGH USB 3.0 FORM A, 0.6M

Pass-through

1 × USB 3.0 (female/male/0.6 m cable) form A

[Link to Product](#)

Illustration

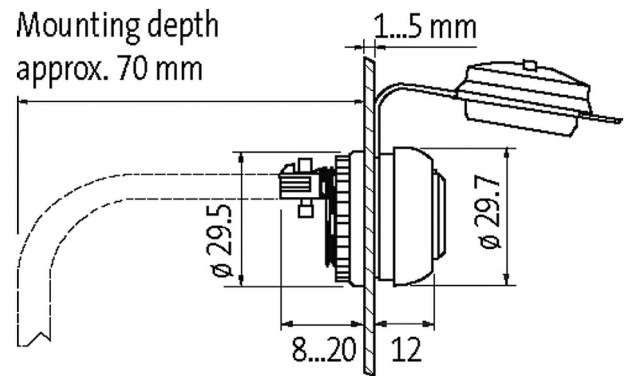

Product may differ from Image



Technical Data

Operating voltage	5 V AC/DC
Operating current	max. 900 mA
Operating current	max. 900 mA
Specification	USB: 3.0 (max. 5 Gbit/s)
Mounting depth mounted	approx. 70 mm

General data

Shielded	yes
Cut-out	Ø 22.5 mm
Protection	IP65
Dimensions H×W×D	29.5×29.5×29 mm

Commercial data

country of origin	CZ
customs tariff number	85444290
EAN	4048879432894
eClass	27143423
Packaging unit	1.000