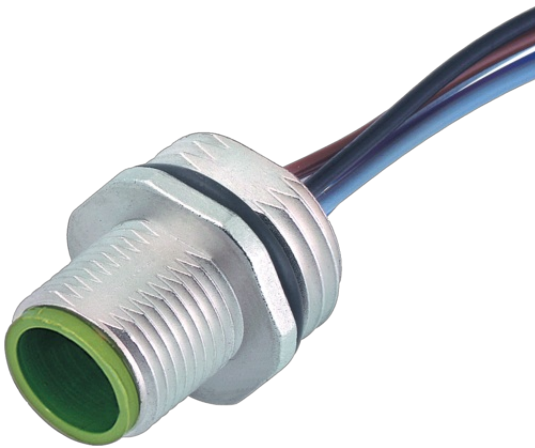

M12 male recept. Y-cod. front

PP-wires AWG20/26 0.3m

Flange male
M12, 8-pole
Y-coded
Front mounting
with multi-strand wire

[Link to Product](#)**Illustration**

1	white/orange
2	orange
3	white/green
4	green
5	blue
6	white
7	brown
8	black

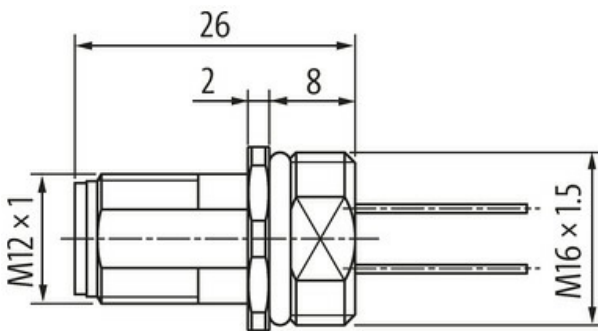
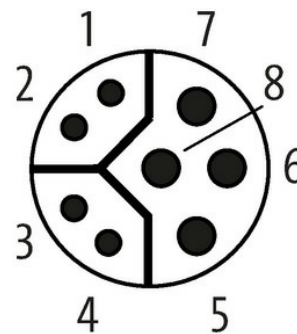
**Male**

Product may differ from Image

Form

Form 15601

Technical Data

Operating voltage	max. 30 V AC/DC
Rated surge voltage	0.8 kV
Operating current per contact	0.5 A (Data), 6 A (Power)
Material group	IEC 60664-1, category I
Coding	Y-coded
LED display	no
Locking of ports	Screw thread (M12x1 mm) recommended torque 0.6 Nm, self-securing

Compression gland	M12 (SW14)
Protection	IP67 inserted and tightened (EN 60529)
Protection NEMA	3, 4, 6P (UL 50E)
Material	Zinc die casting, brass-plated
Locking material	Zinc die casting, matte nickel plated
suitable for corrugated tube (internal Ø)	without

General data

Material (contact)	Copper alloy
Material (contact surface)	Au
Pollution Degree	3
Temperature range	-25...+85 °C

Cables

No./diameter of wires	4× AWG20/19 (0.615) + 1× 4× AWG26/19 (0.155)
Wire isolation	PP (bk, br, wh, bl), (whor, or, whgn, gn)
C-track properties	5 Mio.
Cable number	942
Temperature range (fixed)	-50...+80 °C
Temperature range (mobile)	-40...+80 °C
Bend radius (fixed)	5× outer Ø
Bend radius (moving)	10× outer Ø
Torsion stress	2 Mio. ±30°/m

Commercial data

country of origin	DE
customs tariff number	85444290
EAN	4048879673372
eClass	27279220
Packaging unit	1.000