

M12 male 90° B-cod. with cable shielded

PUR 1x2xAWG24 shielded vt UL/CSA+drag ch. 20m

PROFIBUS

Male 90°

M12, 2-pole

B-coded

shielded

Plastic housings with good resistance against chemicals and oils.

The resistance to aggressive media should be individually tested for your application. Further details on request.

Further cable lengths on request.

[Link to Product](#)

Illustration

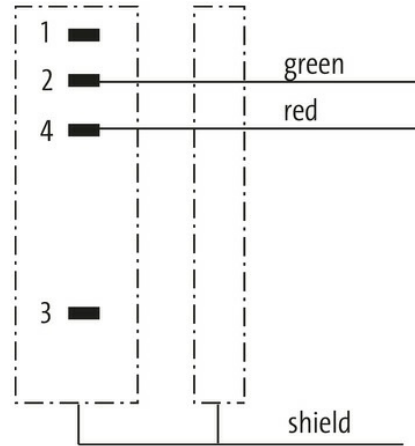

Male

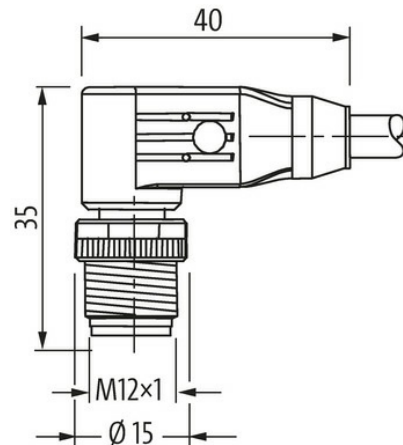
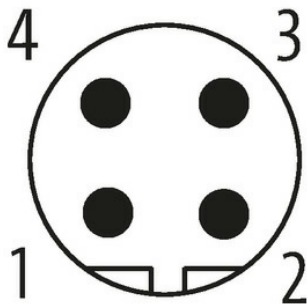

Product may differ from Image



* only for products with UL/CSA approved cable

Form	
Form	14081
Technical Data	
Operating voltage	max. 60 V AC/DC
Operating voltage (only UL listed)	max. 30 V AC/DC
Operating current per contact	max. 4 A
Locking of ports	Screw thread (M12×1 mm) recommended torque 0.6 Nm, self-securing
Protection	IP65, IP66K, IP67 inserted and tightened (EN 60529)
Locking material	Zinc die casting, matte nickel plated
General data	
Temperature range	-25...+85 °C, depending on cable quality
Cables	
Cable identification	841
Approval (cable)	cURus (AWM-Style 20549/10578), CE-conform
Cable weight [g/m]	70,4 g
Material (wire)	Cu wire, bare
Resistor (core)	max. 72 Ω/km (20 °C)
Single wire Ø (core)	0.13 mm
Construction (core)	19× 0.13 mm
AWG	similar to AWG 24
Material (wire isolation)	ZE-PE
Material property (wire isolation)	CFC-, cadmium-, silicone- and lead-free
Shore hardness (wire isolation)	60 ±3 D
Wire-Ø incl. isolation	2.55 mm ±5%
Color/numbering of wires	rd, gn
Shield	yes
optical shield cover	min. 85%
Material (jacket)	PUR
Material property (jacket)	CFC-, cadmium-, silicone- and lead-free, matt, low-adhesion, machine easy to process, abrasion-resistant
Shore hardness (jacket)	87 ±3 A
Outer-Ø (jacket)	7.7 mm ±5%
Color (jacket)	violet
chemical resistance	Oil resistance according to IEC 60811-2-1, ASTM IRM 901, ICEA S-82-552 Std.
thermal resistance	flame-retardant according to UL 1581 section 1090, section 1100 (FT2), IEC 60332-1-2 Std.
Nominal voltage	300 V
Test voltage	2000 V AC (test duration 1 min)
Temperature range (fixed)	-40...+80 °C
Temperature range (mobile)	-20...+60 °C
Bend radius (fixed)	7.5× outer Ø
Bend radius (moving)	12× outer Ø
No. of bending cycles (C-track)	max. 5 Mio. (25 °C)
Travel speed (C-track)	max. 3 m/s
Acceleration (C-track)	max. 5 m/s ²
Commercial data	
country of origin	DE
customs tariff number	85444290
EAN	4048879404457
eClass	27061801

Packaging unit

1.000