

Valve plug MJC 0° with cable LED

RADOX EM 104 2x0.75 bk 20m

Female straight
10...30 V AC/DC
LED

with cable sleeves

Plastic housings with good resistance against chemicals and oils.

The resistance to aggressive media should be individually tested for your application. Further details on request.

Further cable lengths on request.

[Link to Product](#)

Illustration

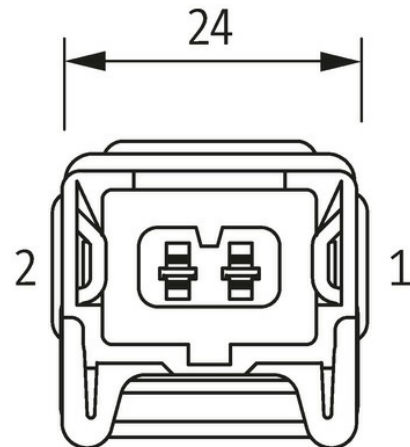
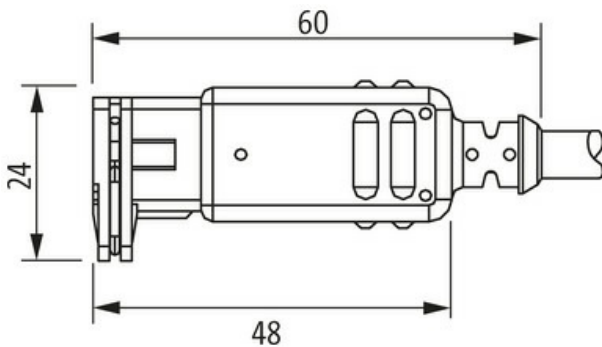
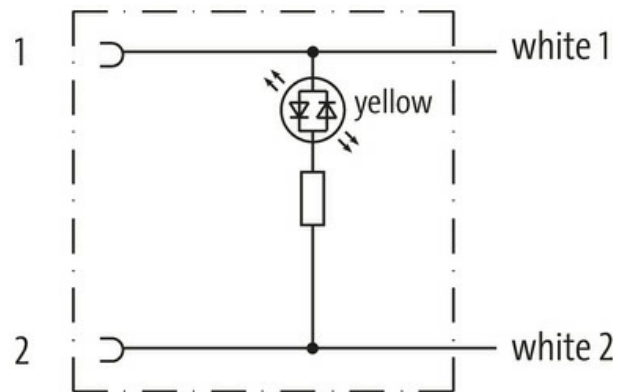

Product may differ from Image

Form

Form 70021

Technical Data

Operating voltage	10...30 V AC/DC
Rated surge voltage	0.8 kV
Operating current per contact	max. 4 A
LED display	yellow
suitable for corrugated tube (internal Ø)	10 mm
Housing	Black plastic, flame retardant

General data	
Pollution Degree	3
Stripping length (jacket)	50 mm
Cables	
Cable identification	R21
Approval (cable)	DIN EN 45545-2, CE conform
Cable weight [g/m]	48,4 g
Material (wire)	Cu wire, tin plated
Resistor (core)	max. 26 Ω /km (20 °C)
Single wire \varnothing (core)	0.23 mm
Construction (core)	19× 0.23 mm
Diameter (core)	2× 0.75 mm ²
AWG	similar to AWG 18
Material (wire isolation)	Radox EI 303
Wire- \varnothing incl. isolation	1.62 mm \pm 5%
Color/numbering of wires	wh (bk num)
Stranding combination	2 wires twisted
Shield	no
Material (jacket)	Radox EM 104
Outer- \varnothing (jacket)	4.75 mm \pm 5%
Color (jacket)	black
Jacket Color	black
Nominal voltage	600/1000 V AC
Test voltage	3500 V AC
Current load capacity	according to DIN VDE 0298-4
Temperature range (fixed)	-50...+120 °C
Temperature range (mobile)	-25...+90 °C
Bend radius (fixed)	3× outer- \varnothing
Bend radius (moving)	4× outer- \varnothing
Commercial data	
country of origin	DE
customs tariff number	85444290
EAN	4048879691222
eClass	27279218
Packaging unit	1.000