

M8 male 0°/M8 female 0° shielded

PUR 6x0,14 shielded UL bk 7m

Male straight – female straight

M8 – M8

6-pole

Further cable lengths on request.

Plastic housings with good resistance against chemicals and oils.

The resistance to aggressive media should be individually tested for your application. Further details on request.

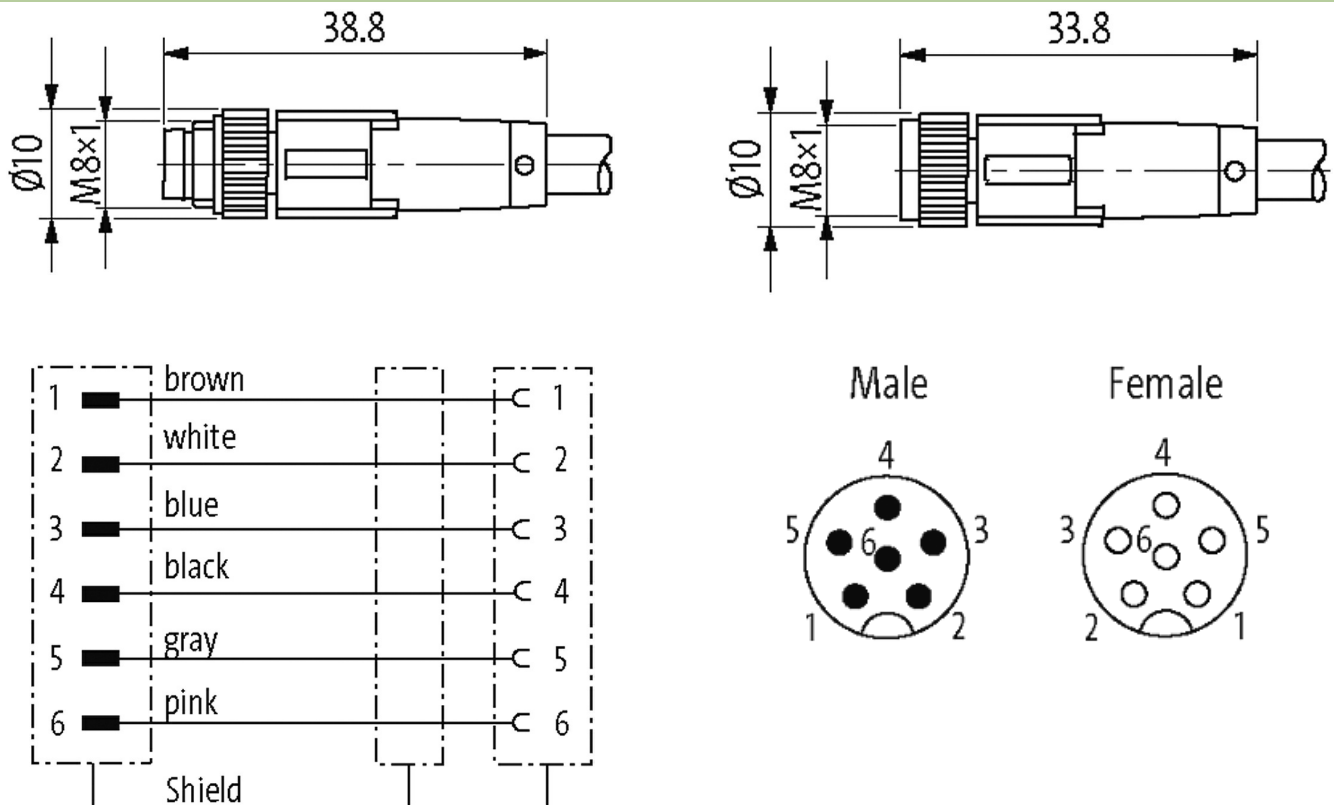
Link to Product**Illustration**

Product may differ from Image

Form

Form 87711

Technical Data

Operating voltage	30 V
Operating current per contact	max. 1.5 A
No. of poles	6
Isolation resistance	≥ 100 MΩ
Coding	A-coded
Locking of ports	Screw thread (M8×1 mm) recommended torque 0.2 Nm, self-securing
Protection	IP65 and IP67 when plugged and screwed down (EN 60529)
Locking material	Zinc die casting, nickel-plated
Material	TPU
Over voltage category	II
Mating cycles	≥ 100

General data	
Standards	DIN EN 61076-2-104 (M8)
Material (contact)	Copper alloy
Material (gasket)	NBR
Pollution Degree	3
Temperature range	-25...+90 °C
Cables	
Cable identification	493
Cable weight [g/m]	37,40
Material (wire)	Cu wire, bare
Single wire Ø (core)	0.1 mm
Construction (core)	18× 0.1 mm
Diameter (core)	6× 0.14 mm ²
AWG	similar to AWG 26
Wire-Ø incl. isolation	1.05 mm ±5%
Color/numbering of wires	br, wh, bl, bk, gr, pk
Shield	yes
Material (jacket)	PUR
Outer-Ø (jacket)	5.2 mm ±5%
Color (jacket)	gray-black RAL 7021
Temperature range (fixed)	-40...+80 °C
Temperature range (mobile)	-5...+80 °C
Bend radius (fixed)	10× outer Ø
Bend radius (moving)	10× outer Ø
No. of bending cycles (C-track)	4 Mio.
Traversing distance (C-track)	max. 10 m
Travel speed (C-track)	max. 3 m/s
Acceleration (C-track)	max. 10 m/s ²
Commercial data	
country of origin	PL
customs tariff number	85444290
EAN	4048879820493
eClass	27260705
Packaging unit	1