

M12 male 90° / M12 female 90° A-cod. shielded F&B

PVC 0.5+0.25 shielded gy 1m

Cube67

Further cable lengths on request.

Male 90° – female 90°

M12 – M12, 6-pole

A-coded

Stainless steel 1.4404 (V4A)

shielded

without cable sleeves

Plastic housings with good resistance against chemicals and oils.

The resistance to aggressive media should be individually tested for your application. Further details on request.

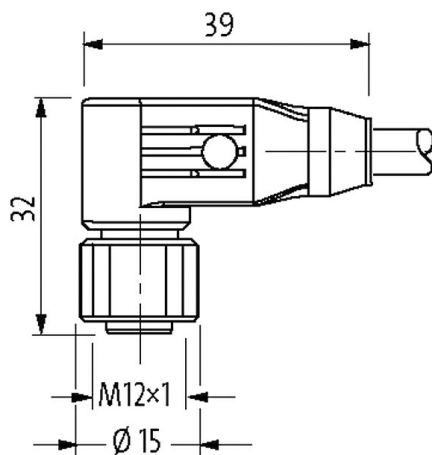
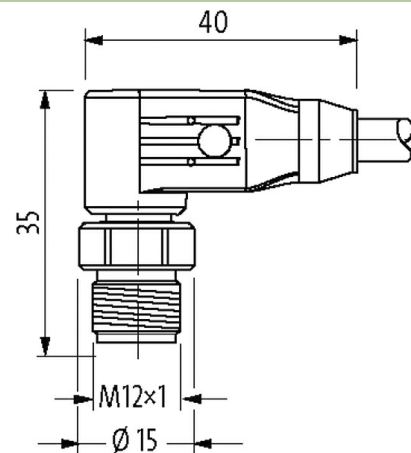
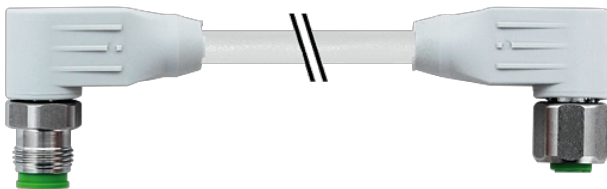
[Link to Product](#)**Illustration**

1	■ brown	⊃ 1
2	■ white	⊃ 2
3	■ blue	⊃ 3
4	■ pink	⊃ 4
5	■ gray	⊃ 5
6	■ black	⊃ 6
Shield		

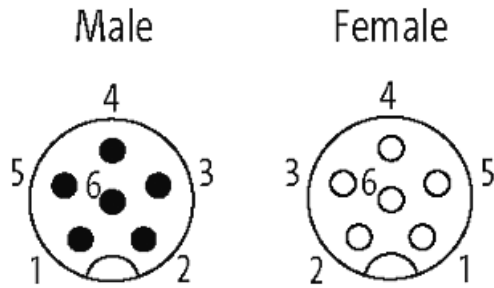

Product may differ from Image

**Form**

Form 46061

Technical Data

Operating voltage	max. 30 V AC/DC
Rated surge voltage	0.8 kV
Operating current per contact	max. 4 A
No. of poles	6
Material group	IEC 60664-1, category I
Coding	A-coded
LED display	no
Locking of ports	Screw thread (M12×1 mm) recommended torque 0.6 Nm, self-securing
Compression gland	M12 (SW14)
Protection	IP65, IP67, IP68 inserted and tightened (EN 60529)
Locking material	Stainless steel 1.4404 (V4A)
suitable for corrugated tube (internal Ø)	without

General data

Mounting method	inserted, tightened
Material (contact)	Copper alloy
Material (contact surface)	Au
Material (gasket)	FKM
Pollution Degree	3
Temperature range	-25...+85 °C, depending on cable quality

Cables

Cable identification	522
Approval (cable)	CE conform
Cable weight [g/m]	104,50
Material (wire)	Cu wire, bare
Resistor (core)	max. 34 Ω/km (20 °C, 0.5 mm ²); max. 75 Ω/km (20 °C, 0.25 mm ²)
Single wire Ø (core)	0.15 mm (0.5 mm ²); 0.1 mm (0.25 mm ²)
Construction (core)	28× 0.15 mm (0.5 mm ²); 32× 0.1 mm (0.25 mm ²); (multi-strand wire class 6)
Diameter (core)	4× 0.5 + 2× 0.25 mm ²
AWG	similar to AWG 20 (0.5 mm ²); similar to AWG 24 (0.25 mm ²)
Material (wire isolation)	TPE-E
Wire-Ø incl. isolation	1.5 mm ±5% (0.5 mm ²); 1.4 mm ±5% (0.25 mm ²)
Color/numbering of wires	(bl, wh, br, bk) + (gr, pk)
Shield	yes
optical shield cover	min. 80%

The information in this brochure has been compiled with the utmost care.

Liability for the correctness completeness and topicality of the information is restricted to gross negligence. Version: 03/22

Material (jacket)	PVC
Outer-Ø (jacket)	7.9 mm ±5%
Color (jacket)	gray
Nominal voltage	500 V AC
Temperature range (fixed)	-30...+90 °C
Temperature range (mobile)	-5...+70 °C
Bend radius (fixed)	5× outer Ø
Bend radius (moving)	10× outer Ø
Traversing distance (C-track)	max. 5 m (horizontal)
Travel speed (C-track)	max. 2 m/s
Acceleration (C-track)	max. 2 m/s ²
Jacket Color	gray

Commercial data

country of origin	DE
customs tariff number	85444290
EAN	4048879720465
eClass	27061801
Packaging unit	1