

M8 female 90° A-cod. with cable LED

PUR 3x0.25 gy UL/CSA 20m

Female 90°

M8, 3-pole

2× LED (PNP)

Art-No. 7005 - M8 Lite - (plastic hexagonal screw) on request

Plastic housings with good resistance against chemicals and oils.

The resistance to aggressive media should be individually tested for your application. Further details on request.

Further cable lengths on request.

[Link to Product](#)**Illustration**

Female

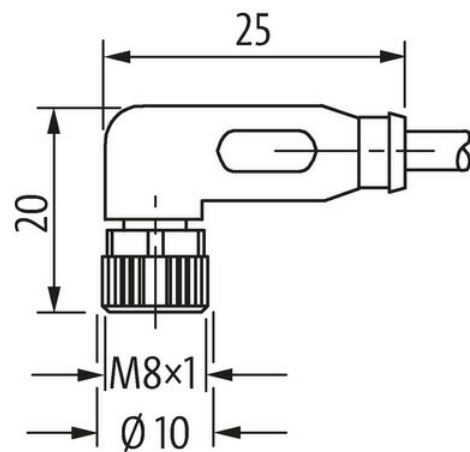

Product may differ from Image



* only for products with UL/CSA approved cable

Form

Form

08121

Technical Data

Operating voltage	24 V DC $\pm 25\%$
Operating voltage (only UL listed)	max. 30 V DC
Rated surge voltage	0.8 kV
Operating current per contact	max. 4 A
Material group	IEC 60664-1, category I
LED display	yellow/green
Locking of ports	Screw thread (M8x1 mm) recommended torque 0.4 Nm, self-securing
Compression gland	M8 (SW9)
Protection	IP65, IP66K, IP67 inserted and tightened (EN 60529)
Material	PUR
Locking material	Zinc die casting, matte nickel plated
suitable for corrugated tube (internal \varnothing)	6.5 mm

General data

Standards	DIN EN 61076-2-104 (M8)
Pollution Degree	3
Temperature range	-25...+85 °C, depending on cable quality

Cables

Cable identification	220
Cable Type	2 (PUR/PVC)
Approval (cable)	UL (AWM-Style 20549/1731), CSA; CE conform
Cable weight [g/m]	26,62 g
Material (wire)	Cu wire, bare
Resistor (core)	max. 79 Ω /km (20 °C)
Single wire \varnothing (core)	0.1 mm
Construction (core)	32x 0.1 mm (multi-strand wire class 6)
Diameter (core)	3x 0.25 mm ²
AWG	similar to AWG 24
Material (wire isolation)	PVC
Material property (wire isolation)	CFC-, cadmium-, silicone- and lead-free
Shore hardness (wire isolation)	43 ± 5 D
Wire- \varnothing incl. isolation	1.25 mm $\pm 5\%$
Color/numbering of wires	br, bk, bl
Stranding combination	3 wires twisted
Shield	no
Material (jacket)	PUR
Material property (jacket)	CFC-, halogen-, cadmium-, silicone- and lead-free, matt, low-adhesion, machine easy to process, abrasion-resistant, hydrolysis and microbial resistant
Shore hardness (jacket)	85 ± 5 A
Outer- \varnothing (jacket)	4.3 mm $\pm 5\%$
Color (jacket)	gray
chemical resistance	good resistance to oil, gasoline and chemicals
Nominal voltage	UL 300 V AC
Test voltage	2000 V AC
Current load capacity	to DIN VDE 0298-4
Temperature range (fixed)	-30...+80 °C
Temperature range (mobile)	-5...+80 °C
Bend radius (fixed)	10x outer \varnothing
Bend radius (moving)	15x outer \varnothing
No. of bending cycles (C-track)	max. 2 Mio. (25 °C)
Travel speed (C-track)	max. 3.3 m/s
Acceleration (C-track)	max. 5 m/s ²

Commercial data

country of origin	DE
-------------------	----

customs tariff number	85444290
EAN	4048879736725
eClass	27279218
Packaging unit	1.000