

M8 female 90° A-cod. with cable LED NPN

PVC 3x0.25 ye UL/CSA 2m

Female 90°
M8, 3-pole
2× LED (PNP)
with cable sleeves

Plastic housings with good resistance against chemicals and oils.

The resistance to aggressive media should be individually tested for your application. Further details on request.

Further cable lengths on request.

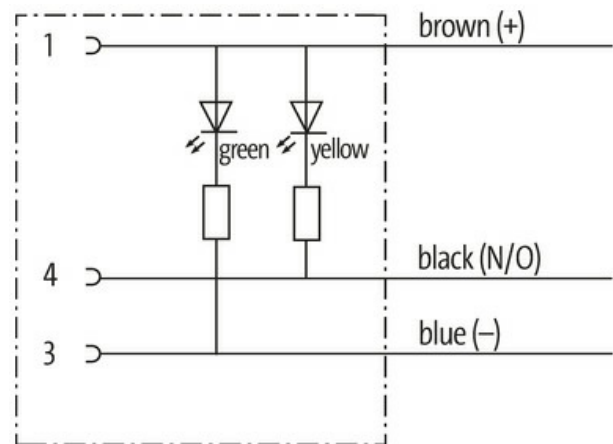
[Link to Product](#)**Illustration**

Female

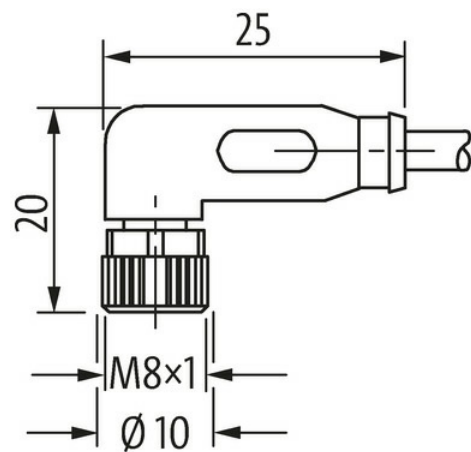
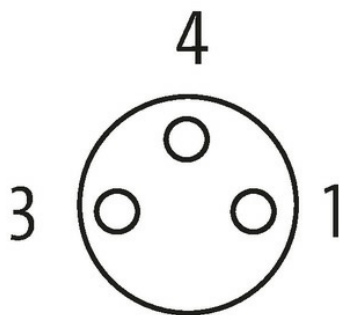

Product may differ from Image



* only for products with UL/CSA approved cable

Form

Form

08125

Technical Data

Operating voltage	24 V DC $\pm 25\%$
Rated surge voltage	0.8 kV
Operating current per contact	max. 4 A
Locking of ports	Screw thread (M8x1 mm) recommended torque 0.4 Nm, self-securing
Protection	IP66K, IP67 inserted and tightened (EN 60529)
Locking material	Zinc die casting, matte nickel plated

Cables

No./diameter of wires	3x 0.25 mm ²
Wire isolation	PVC (br, bl, bk)
Outer Ø	4.5 mm $\pm 5\%$
Cable identification	010
Cable Type	1 (PVC)
Approval (cable)	UL (AWM-Style 2464/1731), CSA
Cable weight [g/m]	29,37 g
Material (wire)	Cu wire, bare
Resistor (core)	max. 79 Ω /km (20 °C)
Single wire Ø (core)	0.15 mm
Construction (core)	14x 0.15 mm (multi-strand wire class 5)
Diameter (core)	3x 0.25 mm ²
AWG	similar to AWG 24
Material (wire isolation)	PVC
Material property (wire isolation)	CFC-, cadmium-, silicone- and lead-free
Shore hardness (wire isolation)	45 ± 5 D
Wire-Ø incl. isolation	1.25 mm $\pm 5\%$
Color/numbering of wires	br, bk, bl
Stranding combination	3 wires twisted
Shield	no
Material (jacket)	PVC
Material property (jacket)	CFC-, cadmium-, silicone- and lead-free
Shore hardness (jacket)	85 ± 5 A
Outer-Ø (jacket)	4.5 mm $\pm 5\%$
Color (jacket)	yellow
Jacket Color	yellow
chemical resistance	good resistance to oil, gasoline and chemicals
thermal resistance	flame retardant UL 1581 VW1 / CSA FT1
Nominal voltage	UL 300 V AC
Test voltage	2000 V AC
Current load capacity	to DIN VDE 0298-4
Temperature range (fixed)	-30...+80 °C
Temperature range (fixed)	-30...+80 °C
Temperature range (mobile)	-5...+80 °C
Temperature range (mobile)	-5...+80 °C
Bend radius (fixed)	5x outer Ø
Bend radius (moving)	10x outer Ø
Bend radius (moving)	10x outer Ø
Material (jacket)	PVC (UL/CSA)

Commercial data

country of origin	DE
customs tariff number	85444290
EAN	4048879470780
eClass	27279218
Packaging unit	1.000