

Valve plug MJC 0° with cable LED

PUR 2x0.5 bk drag ch. 2m

Female straight
10...30 V AC/DC
LED

Plastic housings with good resistance against chemicals and oils.

The resistance to aggressive media should be individually tested for your application. Further details on request.

Further cable lengths on request.

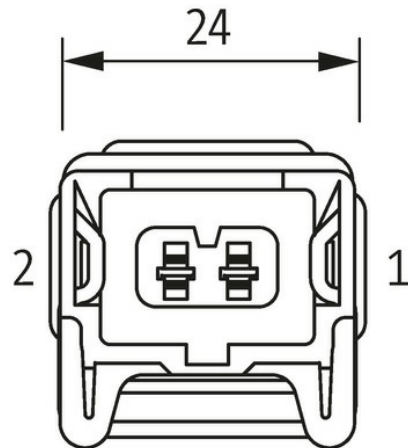
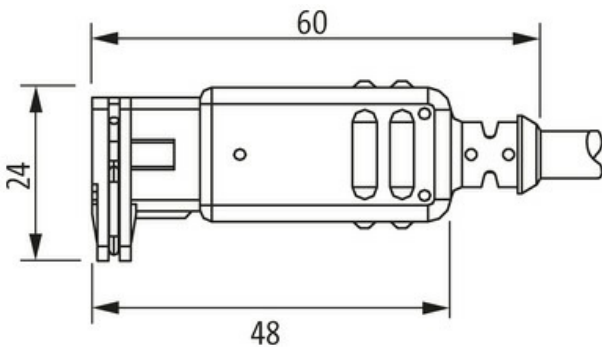
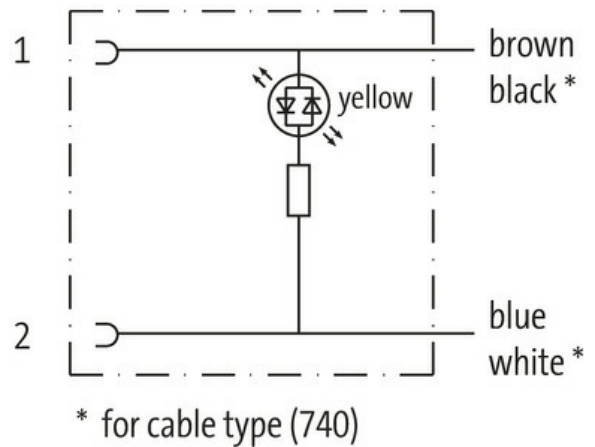
[Link to Product](#)**Illustration**

Product may differ from Image

Form

Form 70021

Technical Data

Operating voltage	10...30 V AC/DC
Rated surge voltage	0.8 kV
Operating current per contact	max. 4 A
Current consumption	approx. 12 mA
LED display	(yellow)

Protection	IP65 inserted and tightened (EN 60529)
Housing	Black plastic, flame retardant

General data

Temperature range	-25...+85 °C, depending on cable quality
-------------------	--

Cables

No./diameter of wires	2× 0.5 mm ²
Wire isolation	TPE (bk, wh)
C-track properties	2 Mio.
Outer Ø	5.0 mm ±5%
Cable identification	740
Approval (cable)	CE conform
Cable weight [g/m]	36,3 g
Material (wire)	Cu wire, bare
Resistor (core)	max. 39 Ω/km (20 °C)
Single wire Ø (core)	0.1 mm
Construction (core)	64× 0.1 mm (multi-strand wire class 6)
Diameter (core)	2× 0.5 mm ²
AWG	similar to AWG 20
Material (wire isolation)	TPE-E
Wire-Ø incl. isolation	1.5 mm ±5%
Color/numbering of wires	bk, wh
Stranding combination	2 wires twisted
Shield	no
Material (jacket)	PUR
Outer-Ø (jacket)	5.0 mm ±5%
Color (jacket)	black
Jacket Color	black
Nominal voltage	300/500 V AC
Test voltage	2000 V AC
Temperature range (fixed)	-50...+90 °C
Temperature range (fixed)	-50...+90 °C
Temperature range (mobile)	-30...+90 °C
Temperature range (mobile)	-30...+90 °C
Bend radius (moving)	10× outer Ø
Bend radius (moving)	10× outer Ø
No. of bending cycles (C-track)	max. 2 Mio. (25 °C)
Travel speed (C-track)	max. 3.3 m/s
Acceleration (C-track)	max. 5 m/s ²
Material (jacket)	PUR

Commercial data

country of origin	DE
customs tariff number	85444290
EAN	4048879459150
eClass	27279218
Packaging unit	1.000