

M23 FEMALE, 90° 19 POLE

PUR 12x0.34+3X0.75 GRAY, drag ch 15m

Female 90°

M23, 19-pole

15-pole used

with cable sleeves

Further cable lengths on request.

Plastic housings with good resistance against chemicals and oils.

The resistance to aggressive media should be individually tested for your application. Further details on request.

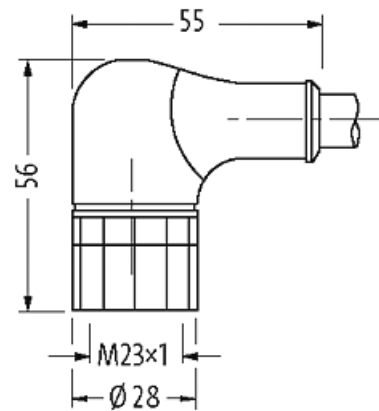
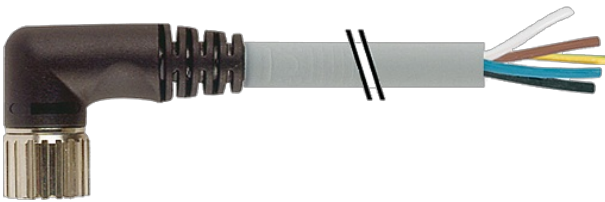
[Link to Product](#)**Illustration**

15	white
7	gray/pink
5	green
	red/blue
4	yellow
16	white/green
8	gray
3	brown/green
14	pink
17	white/yellow
9	red
2	yellow/brown
13	brown 0.75 mm ²
19	blue 0.75 mm ²
6	green/yellow 0.75 mm ²
12	

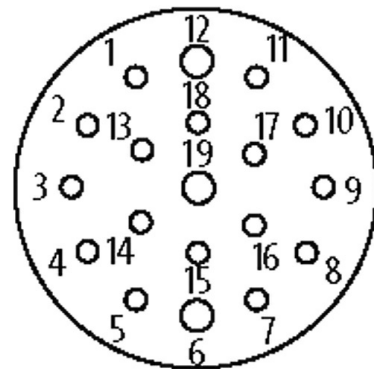
Female

Product may differ from Image

Form

Form 23331

Technical Data

Operating voltage	max. 125 V AC/DC
Operating current per contact	max. 7.5 A
Locking of ports	Screw thread (M23×1 mm) recommended torque 2.0 Nm, self-securing
Protection	IP67 inserted and tightened (EN 60529)
Compression gland	M23 (SW27)

Cables

Cable number	388
No./diameter of wires	12× 0.34 + 3× 0.75 mm ²
Wire isolation	PVC (yebr, rd, grpk, wh, rdbl, gn, whgn, ye, brgn, gr, whye, pk, br, gnye, bl)
C-track properties	2 Mio.
Jacket Color	gray
Material (jacket)	PUR/PVC
Outer Ø	9.8 mm ±5%
Bend radius (fixed)	10× outer Ø
Bend radius (moving)	12× outer Ø
Temperature range (fixed)	-30...+80 °C
Temperature range (mobile)	-5...+70 °C
Color (jacket)	gray

Commercial data

country of origin	DE
customs tariff number	85444290
EAN	4048879187886
eClass	27279218
Packaging unit	1