

M12 female 90° A-cod. with cable LED

PVC 4x0.34 gy UL/CSA 35m

Female 90°

M12, 4-pole

3x LED (PNP)

Art-No. 7005 - M12 Lite - (plastic hexagonal screw) on request

Plastic housings with good resistance against chemicals and oils.

The resistance to aggressive media should be individually tested for your application. Further details on request.

Further cable lengths on request.

[Link to Product](#)

Illustration



Female

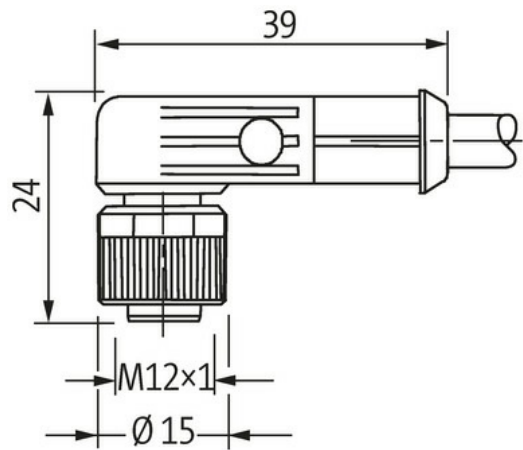
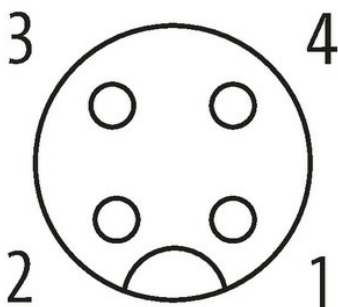

Product may differ from Image



* only for products with UL/CSA approved cable

Form

Form 12421

Technical Data

Operating voltage 24 V DC ±25%

Operating voltage (only UL listed)	max. 30 V DC
Rated surge voltage	0.8 kV
Operating current per contact	max. 4 A
Material group	IEC 60664-1, category I
Coding	A-coded
LED display	LED (green): Power / LED (yellow): (S1) / LED (white): Signal (S2)
Locking of ports	Screw thread (M12×1 mm) recommended torque 0.6 Nm, self-securing
Compression gland	M12 (SW13)
Protection	IP65, IP66K, IP67 inserted and tightened (EN 60529)
Material	PUR
Locking material	Zinc die casting, matte nickel plated
suitable for corrugated tube (internal Ø)	10 mm

General data

Standards	DIN EN 61076-2-101 (M12)
Pollution Degree	3
Temperature range	-25...+85 °C, depending on cable quality

Cables

Cable identification	214
Cable Type	1 (PVC)
Approval (cable)	UL (AWM-Style 2464/1731), CSA
Cable weight [g/m]	40,7 g
Material (wire)	Cu wire, bare
Resistor (core)	max. 60 Ω/km (20 °C)
Single wire Ø (core)	0.15 mm
Construction (core)	19× 0.15 mm (multi-strand wire class 5)
Diameter (core)	4× 0.34 mm ²
AWG	similar to AWG 22
Material (wire isolation)	PVC
Material property (wire isolation)	CFC-, cadmium-, silicone- and lead-free
Shore hardness (wire isolation)	45 ±5 D
Wire-Ø incl. isolation	1.25 mm ±5%
Color/numbering of wires	br, bk, bl, wh
Stranding combination	4 wires twisted
Shield	no
Material (jacket)	PVC
Material property (jacket)	CFC-, cadmium-, silicone- and lead-free
Shore hardness (jacket)	85 ±5 A
Outer-Ø (jacket)	5.0 mm ±5%
Color (jacket)	gray
Cable print	-
chemical resistance	good resistance to oil, gasoline and chemicals
thermal resistance	flame retardant UL 1581 VW1 / CSA FT1
Nominal voltage	UL 300 V AC
Test voltage	2000 V AC
Current load capacity	to DIN VDE 0298-4
Temperature range (fixed)	-30...+80 °C
Temperature range (mobile)	-5...+80 °C
Bend radius (fixed)	5× outer Ø
Bend radius (moving)	10× outer Ø

Commercial data

country of origin	DE
customs tariff number	85444290
EAN	4048879562331

eClass	27279218
Packaging unit	1.000
