

M12 male 0°/ M12 female recept. A-cod. shielded

PUR 0.20+0.38 shielded gn UL/CSA+drag ch. 10m

Ethernet CAT5

Male straight – flange female straight

M12 – M12, 8-pole

shielded

Further cable lengths on request.

Plastic housings with good resistance against chemicals and oils.

The resistance to aggressive media should be individually tested for your application. Further details on request.

[Link to Product](#)**Illustration**

Male

Female

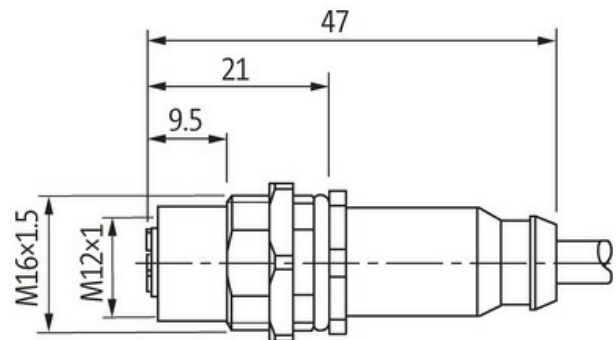
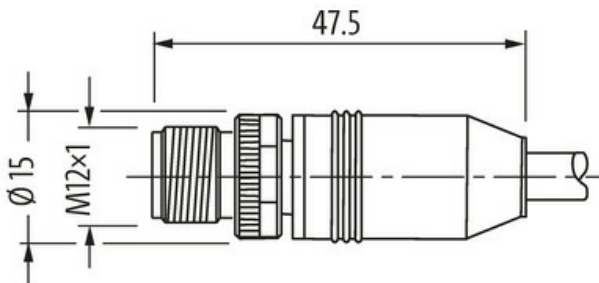
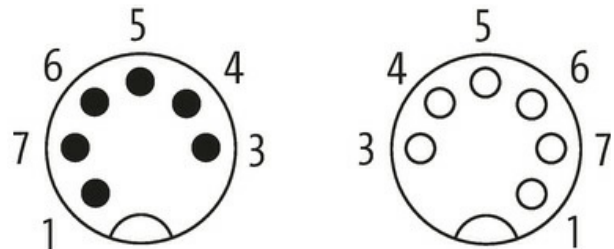

Product may differ from Image



Form

Form SS085

Technical Data

Operating voltage	max. 30 V AC/DC
Rated surge voltage	0.8 kV
Operating current per contact	max. 2 A
Transfer parameters	CAT5, Class D (ISO/IEC 11801:2002), (EN 50173-1)
Transfer rate	up to 100 Mbit/s full duplex
Material group	IEC 60664-1, category I

Coding	A-coded
Locking of ports	Screw thread (M12×1 mm) recommended torque 0.6 Nm, self-securing
Compression gland	M12 (SW13)
Protection	IP67 inserted and tightened (EN 60529)
Protection NEMA	3, 4, 6P (UL 50E)
Material	PUR
Locking material	Zinc die casting, matte nickel plated

General data

Pollution Degree	3
Temperature range	-25...+85 °C, depending on cable quality

Cables

No./diameter of wires	2× 2× 0.20 + 1× 2× 0.38
Wire isolation	PO (gnye, pkbl, rdbk)
C-track properties	5 Mio.
Outer Ø	6.9 mm ±5%
Cable number	880
Shield	yes
optical shield cover	min. 85%
Material (jacket)	PUR
Jacket Color	green
Temperature range (fixed)	-20...+80 °C
Temperature range (mobile)	-20...+60 °C
Bend radius (moving)	10× outer Ø
Torsion stress	±30°/m
Material (jacket)	PUR (UL/CSA)

Commercial data

country of origin	DE
customs tariff number	85444290
EAN	4048879618212
eClass	27061801
Packaging unit	1.000