

M8 male 0° / M12 female 0° A-cod. shielded

PUR 1x4xAWG26 shielded gn UL/CSA+drag ch. 10m

EtherCAT

Male straight – female straight

M8 – M12, 4-pole

D-coded

shielded

Plastic housings with good resistance against chemicals and oils.

The resistance to aggressive media should be individually tested for your application. Further details on request.

Further cable lengths on request.

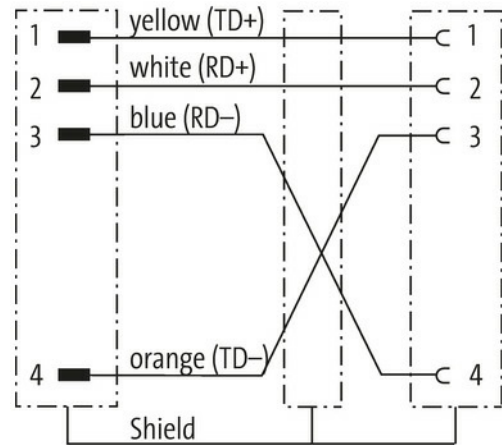
[Link to Product](#)**Illustration**

Male



Female

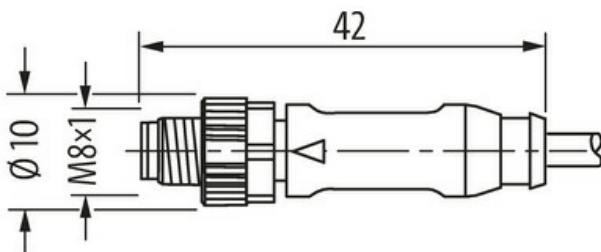
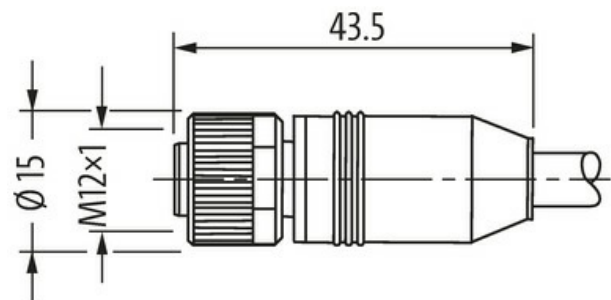
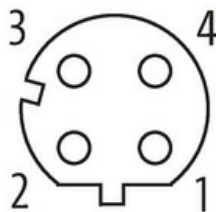

Product may differ from Image



* only for products with UL/CSA approved cable

Form	
Form	89851
Technical Data	
Operating voltage	max. 60 V DC
Operating voltage (only UL listed)	max. 30 V DC
Rated surge voltage	1.5 kV
Operating current per contact	max. 4 A
Transfer parameters	CAT5, Class D (ISO/IEC 11801:2002), (EN 50173-1)
Transfer rate	up to 100 Mbit/s full duplex
Material group	IEC 60664-1, category I
Coding	M12, D-coded
Locking of ports	Screw thread (M8/M12×1 mm) recommended torque 0.4/0.6 Nm, self-securing
Compression gland	M8 (SW9), M12 (SW13)
Protection	IP67 inserted and tightened (EN 60529)
Material	PUR
Locking material	Zinc die casting, matte nickel plated
suitable for corrugated tube (internal Ø)	6.5 mm
General data	
Standards	DIN EN 61076-2-101 (M12), DIN EN 61076-2-104 (M8)
Material (gasket)	FKM
Pollution Degree	3
Temperature range	-25...+85 °C, depending on cable quality
Cables	
Cable identification	791
Approval (cable)	cURus (AWM-Style 20549/10493); CE conform
Cable weight [g/m]	59,4 g
Material (wire)	Cu wire, bare
Resistor (core)	max. 139.3 Ω/km (20 °C)
Single wire Ø (core)	0.15 mm
Construction (core)	19× 0.15 mm (multi-strand wire class 5)
Diameter (core)	1 × 4× AWG26
AWG	similar to AWG 26
Material (wire isolation)	PO
Wire-Ø incl. isolation	1.0 mm ±5%
Color/numbering of wires	wh, or, bl, ye
Stranding combination	4 wires twisted
Shield	yes
optical shield cover	min. 85%
Material (jacket)	PUR
Material property (jacket)	CFC-, halogen-, cadmium-, silicone- and lead-free
Outer-Ø (jacket)	4.9 mm ±5%
Color (jacket)	green
chemical resistance	Oil resistance according to IEC 60811-2-1, ASTM IRM 901, ICEA S-82-552 Std.
thermal resistance	flame retardant
Temperature range (fixed)	-40...+80 °C
Temperature range (mobile)	-30...+70 °C
Bend radius (fixed)	7.5× outer Ø

Bend radius (moving)	12× outer Ø
No. of bending cycles (C-track)	max. 5 Mio. (25 °C)
Travel speed (C-track)	max. 3 m/s
Acceleration (C-track)	max. 5 m/s ²

Commercial data

country of origin	DE
customs tariff number	85444290
EAN	4048879897716
eClass	27061801
Packaging unit	1.000