

M12 male 90° / M8 female 90° A-cod.

PUR 3x0.25 bk UL/CSA 18m

Male 90° – female 90°

M12 – M8, 3-pole

Plastic housings with good resistance against chemicals and oils.

The resistance to aggressive media should be individually tested for your application. Further details on request.

Further cable lengths on request.

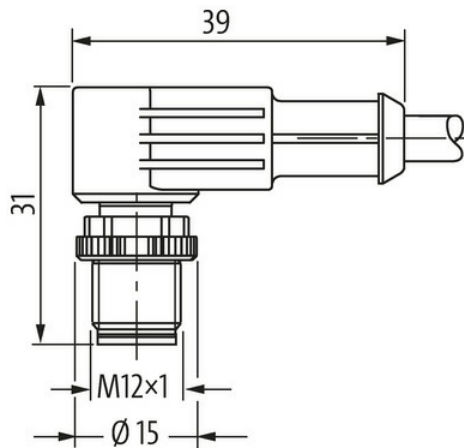
[Link to Product](#)**Illustration**

Male



Female

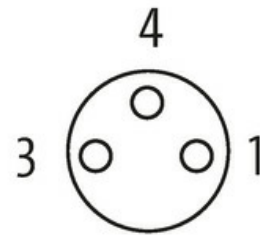



Product may differ from Image



* only for products with UL/CSA approved cable

Form

Form 40681

Technical Data

Operating voltage	max. 50 V AC/60 V DC
Operating voltage (only UL listed)	max. 30 V AC/DC
Rated surge voltage	1.5 kV
Operating current per contact	max. 4 A
Material group	IEC 60664-1, category I
Locking of ports	Screw thread (M8/M12×1 mm) recommended torque 0.4/0.6 Nm, self-securing
Compression gland	M8 (SW9), M12 (SW13)
Protection	IP66K, IP67 inserted and tightened (EN 60529)
Material	PUR
Locking material	Zinc die casting, nickel-plated
suitable for corrugated tube (internal Ø)	M12 (10 mm); M8 (6.5 mm)

General data

Standards	DIN EN 61076-2-101 (M12), DIN EN 61076-2-104 (M8)
Pollution Degree	3
Temperature range	-25...+85 °C, depending on cable quality

Cables

Cable identification	620
Cable Type	2 (PUR/PVC)
Approval (cable)	UL (AWM-Style 20549/1731), CSA; CE conform
Cable weight [g/m]	26,62 g
Material (wire)	Cu wire, bare
Resistor (core)	max. 79 Ω/km (20 °C)
Single wire Ø (core)	0.1 mm
Construction (core)	32× 0.1 mm (multi-strand wire class 6)
Diameter (core)	3× 0.25 mm ²
AWG	similar to AWG 24
Material (wire isolation)	PVC
Material property (wire isolation)	CFC-, cadmium-, silicone- and lead-free
Shore hardness (wire isolation)	43 ±5 D
Wire-Ø incl. isolation	1.25 mm ±5%

The information in this brochure has been compiled with the utmost care.
 Liability for the correctness completeness and topicality of the information is restricted to gross negligence. Version: 03/22

Color/numbering of wires	br, bk, bl
Stranding combination	3 wires twisted
Shield	no
Material (jacket)	PUR
Material property (jacket)	CFC-, halogen-, cadmium-, silicone- and lead-free, matt, low-adhesion, machine easy to process, abrasion-resistant, hydrolysis and microbial resistant
Shore hardness (jacket)	85 ±5 A
Outer-Ø (jacket)	4.3 mm ±5%
Color (jacket)	black
chemical resistance	good resistance to oil, gasoline and chemicals
Nominal voltage	UL 300 V AC
Test voltage	2000 V AC
Current load capacity	to DIN VDE 0298-4
Temperature range (fixed)	-30...+80 °C
Temperature range (mobile)	-5...+80 °C
Bend radius (fixed)	10× outer Ø
Bend radius (moving)	15× outer Ø
No. of bending cycles (C-track)	max. 2 Mio. (25 °C)
Travel speed (C-track)	max. 3.3 m/s
Acceleration (C-track)	max. 5 m/s ²

Commercial data

country of origin	DE
customs tariff number	85444290
EAN	4048879158183
eClass	27279218
Packaging unit	1.000