

**M12 male 90° A-cod. with cable shielded**

PUR 3x0.34 shielded gy 3m

Male 90°  
M12, 3-pole  
shielded  
A-coded

Plastic housings with good resistance against chemicals and oils.

The resistance to aggressive media should be individually tested for your application. Further details on request.  
Further cable lengths on request.

[Link to Product](#)

Illustration

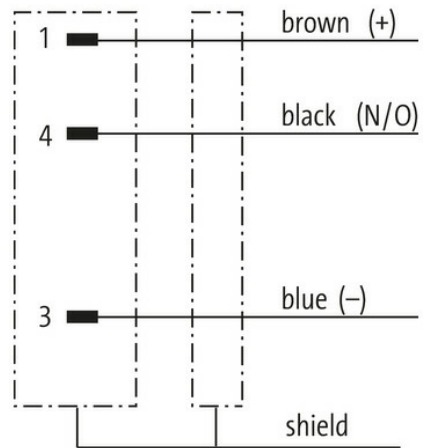
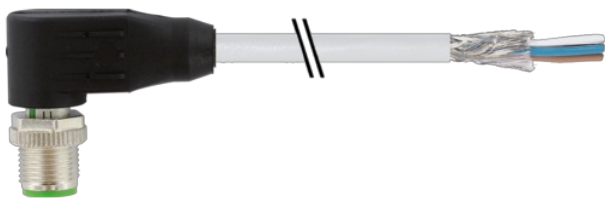

Male

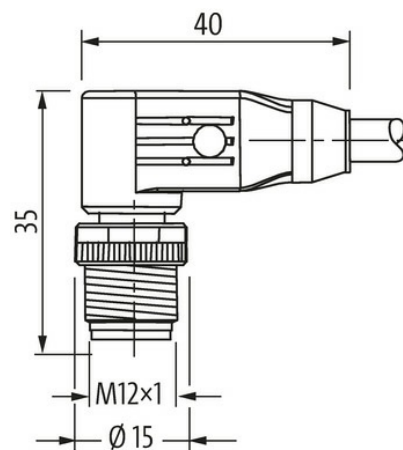
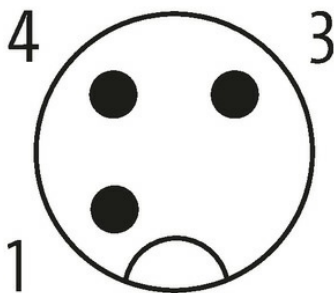

Product may differ from Image



\* only for products with UL/CSA approved cable

Form

The information in this brochure has been compiled with the utmost care.  
Liability for the correctness completeness and topicality of the information is restricted to gross negligence. Version: 03/22

Form	13121
<b>Technical Data</b>	
Operating voltage	max. 60 V AC/DC
Operating voltage (only UL listed)	30 V AC/DC
Rated surge voltage	1.5 kV
Operating current per contact	max. 4 A
No. of poles	3
Material group	IEC 60664-1, category I
Coding	A-coded
LED display	no
Locking of ports	Screw thread (M12×1 mm) recommended torque 0.6 Nm, self-securing
Compression gland	M12 (SW13)
Protection	IP65, IP66K, IP67 inserted and tightened (EN 60529)
Material	PUR
Locking material	Zinc die casting, matte nickel plated
<b>General data</b>	
Standards	DIN EN 61076-2-101 (M12)
Mounting method	inserted, tightened
Material (contact)	Copper alloy
Material (contact surface)	Au
Pollution Degree	3
Stripping length (jacket)	20 mm
Temperature range	-25...+85 °C, depending on cable quality
<b>Cables</b>	
No./diameter of wires	3× 0.34 mm <sup>2</sup>
Wire isolation	PVC (br, bl, bk)
Outer Ø	5.9 mm ±5%
Cable number	318
Approval (cable)	CE conform
Shield	yes
Color (jacket)	gray
Jacket Color	gray
Temperature range (fixed)	-30...+80 °C
Temperature range (mobile)	-5...+70 °C
Bend radius (fixed)	10× outer Ø
Bend radius (moving)	15× outer Ø
Material (jacket)	PUR/PVC
<b>Commercial data</b>	
country of origin	DE
customs tariff number	85444290
EAN	4048879200769
eClass	27279218
Packaging unit	1.000