

7/8" male 90° / 7/8" female 90°

PUR 5x1.5 gy UL/CSA+drag ch. 7m

Male 90° – female 90°

7/8" – 7/8", 5-pole

Power cable

Further cable lengths on request.

Plastic housings with good resistance against chemicals and oils.

The resistance to aggressive media should be individually tested for your application. Further details on request.

[Link to Product](#)

Illustration

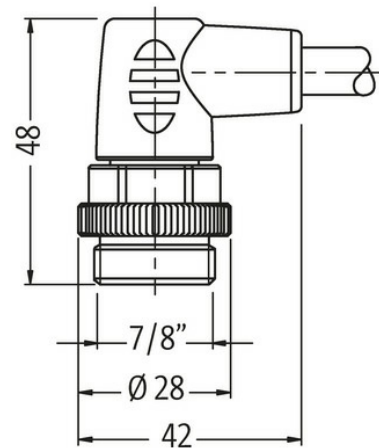
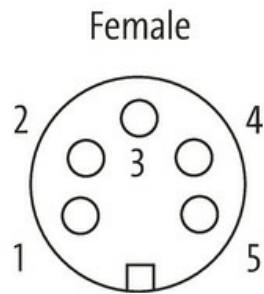
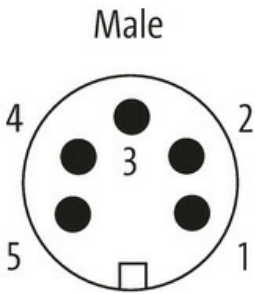
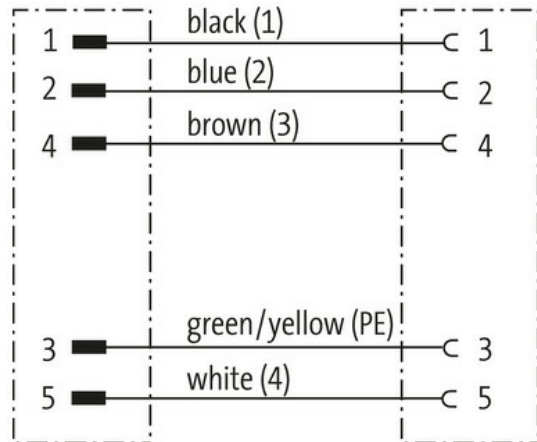
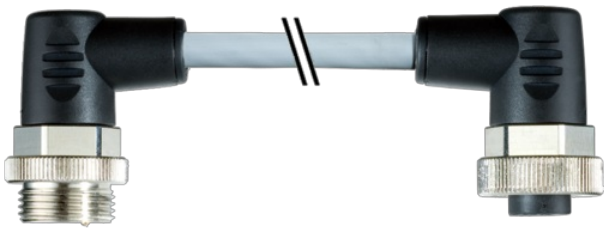



Product may differ from Image

**Form**

Form 50051

Technical Data

Operating voltage	max. 230/400 V AC/DC
Rated surge voltage	3.0 kV
Operating current per contact	max. 12 A
Locking of ports	Screw thread 7/8" (recommended torque 1.5 Nm) self-securing
Protection	IP67 inserted and tightened (EN 60529)

General data

Temperature range -25...+85 °C, depending on cable quality

Cables

Cable identification	961
Cable Type	3 (PUR)
Cable weight [g/m]	129,8 g
Material (wire)	Cu wire, bare
Resistor (core)	max. 13.3 Ω/km (20 °C)
Single wire Ø (core)	0.15 mm
Construction (core)	84× 0.15 mm (multi-strand wire class 6)
Diameter (core)	5× 1.5 mm ²
AWG	similar to AWG 16
Material (wire isolation)	PP
Material property (wire isolation)	CFC-, halogen-, cadmium-, silicone- and lead-free
Shore hardness (wire isolation)	60 ±5 D
Wire-Ø incl. isolation	2.3 mm ±5%
Color/numbering of wires	bl, bk, wh, br, num; gnye longitudinally striped
Stranding combination	5 wires twisted around central filler
Shield	no
Material (jacket)	PUR
Material property (jacket)	CFC-, halogen-, cadmium-, silicone- and lead-free, matt, low-adhesion, machine easy to process, abrasion-resistant, hydrolysis and microbial resistant
Shore hardness (jacket)	90 ±5 A
Outer-Ø (jacket)	8.0 mm ±5%
Color (jacket)	gray

The information in this brochure has been compiled with the utmost care.

Liability for the correctness completeness and topicality of the information is restricted to gross negligence. Version: 03/22

chemical resistance	good resistance to oil, gasoline and chemicals (EN 60811-404)
thermal resistance	flame retardant UL 1581 VW1 / CSA FT1 / IEC 60332-1, IEC 60332-2-2
Nominal voltage	1000 V AC
Test voltage	10.0 kV
Current load capacity	to DIN VDE 0298-4
Temperature range (fixed)	-50...+80 °C, (+90 °C at max. 10 000 operating hours)
Temperature range (mobile)	-25...+80 °C, (+90 °C at max. 10 000 operating hours)
Bend radius (fixed)	7.5× outer Ø
Bend radius (moving)	10× outer Ø
No. of bending cycles (C-track)	max. 5 Mio. (25 °C)
Travel speed (C-track)	max. 3.3 m/s
Acceleration (C-track)	max. 5 m/s ²
Torsion stress	±180°/m
No. of torsion cycles	max. 2 Mio. (25 °C)
Torsion speed	35 cycles/min

Commercial data

country of origin	CZ
customs tariff number	85444290
EAN	4048879536608
eClass	27279218
Packaging unit	1.000