

MQ15-X-Power fem. receptable shielded front mount

wires PVC 6x2.5 0,5m

Flange female

MQ15, 6-pole

with multi-strand wire

shielded housing

Front mounting

Plastic housings with good resistance against chemicals and oils.

The resistance to aggressive media should be individually tested for your application. Further details on request.

Further cable lengths on request.

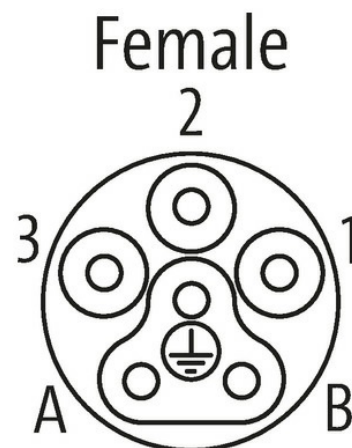
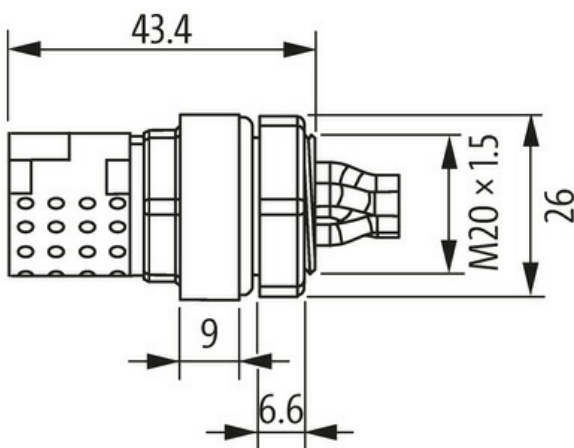
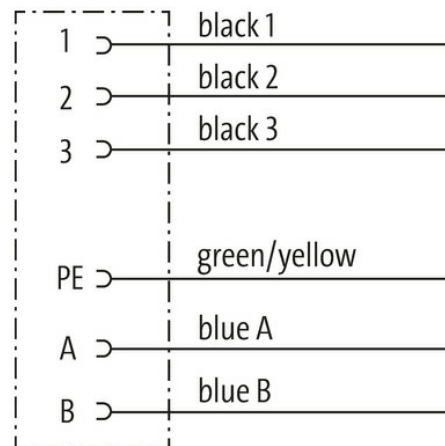
[Link to Product](#)**Illustration**

Product may differ from Image

Form

Form P8391

Technical Data

Operating voltage	max. 600 V AC (Power); max. 63 V AC/DC (Signal)
Rated surge voltage	2.5 kV
Operating current per contact	max. 16 A (Power); max. 10 A (Signal)
No. of poles	6
Material group	IEC 60664-1, category I

The information in this brochure has been compiled with the utmost care.

Liability for the correctness completeness and topicality of the information is restricted to gross negligence. Version: 03/22

Murrelektronik Ltd. | 5 Albion Street, Pendlebury Industrial Estate, Swinton | Manchester M27 4FG | Fon +44 161 728 3133 | Fax +44 161 728 3130 | shop@murrelektronik.co.uk | shop.murrelektronik.co.uk

Mating cycles	≥ 500
LED display	no
Locking of ports	Quick connection, 1/4 turn
Protection	IP67 inserted and tightened (EN 60529)
Material	Brass, nickel plated
Configuration	fully used

General data

Mounting method	inserted, tightened
Material (contact)	Copper alloy
Material (contact surface)	Ag
Pollution Degree	3
Temperature range	-40...+90 °C, depending on cable quality
Material (contact carrier)	PA

Cables

No./diameter of wires	6× 2.5 mm ²
Wire isolation	PVC (bk, bl, num, gnye)
Outer Ø	3.7 mm ±5%
Cable identification	P80
Cable number	P80
Material (wire)	Cu wire, tin plated
Construction (core)	multi-strand wire class 5 (EN 60228)
Diameter (core)	6× 2.5 mm ²
AWG	similar to AWG 14
Material (wire isolation)	PVC
Wire-Ø incl. isolation	3.7 mm ±5%
thermal resistance	flame retardant UL VW1, CSA FT1
Nominal voltage	600 V
Test voltage	2500 V AC

Commercial data

country of origin	DE
customs tariff number	85444290
EAN	4048879701846
eClass	27279221
Packaging unit	1.000