

M12 male 90° / M12 male 90° D-cod. shielded

PUR 1x4xAWG22 shielded vt UL/CSA+drag ch. 7m

Ethernet CAT5
 Male 90° – male 90°
 M12 – M12, 4-pole
 D-coded
 shielded

Transmission properties with channel transmission up to 100 m
 Further cable lengths on request.

Plastic housings with good resistance against chemicals and oils.

The resistance to aggressive media should be individually tested for your application. Further details on request.

[Link to Product](#)

Illustration



Male

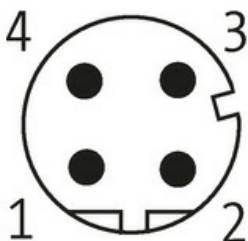

Male

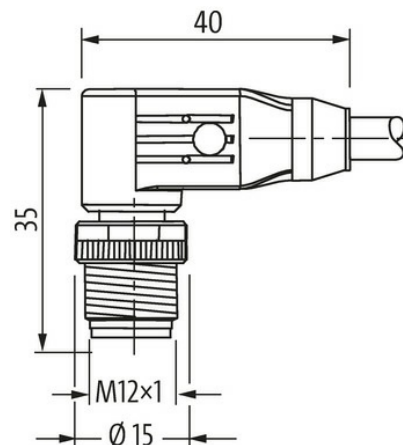
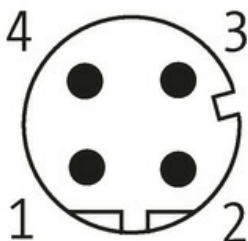

Product may differ from Image



* only for products with UL/CSA approved cable

Form	
Form	44561
Technical Data	
Operating voltage	max. 60 V DC
Operating voltage (only UL listed)	30 V DC
Rated surge voltage	1.5 kV
Operating current per contact	max. 4 A
No. of poles	4
Transfer parameters	CAT5, Class D (ISO/IEC 11801:2002), (EN 50173-1)
Transfer rate	up to 100 Mbit/s full duplex
Material group	IEC 60664-1, category I
Coding	D-coded
LED display	no
Locking of ports	Screw thread (M12×1 mm) recommended torque 0.6 Nm, self-securing
Compression gland	M12 (SW13)
Protection	IP65, IP66K, IP67 inserted and tightened (EN 60529)
Material	PUR
Locking material	Zinc die casting, matte nickel plated
suitable for corrugated tube (internal Ø)	without
General data	
Standards	DIN EN 61076-2-101 (M12)
Mounting method	inserted, tightened
Pollution Degree	3
Temperature range	-25...+85 °C, depending on cable quality
Cables	
Cable identification	798
Approval (cable)	cURus (AWM-Style 20549/11602), CE-conform
Cable weight [g/m]	68,64 g
Material (wire)	Cu wire, bare
Resistor (core)	max. 55 Ω/km (20 °C)
Construction (core)	19× 0.15 mm (multi-strand wire class 5)
Diameter (core)	1 × 4× AWG22/7
AWG	similar to AWG 22
Material (wire isolation)	PO
Material property (wire isolation)	CFC-, halogen-, cadmium-, silicone- and lead-free
Wire-Ø incl. isolation	1.4 mm ±5%
Color/numbering of wires	wh, ye, bl, or
Shield	yes
optical shield cover	min. 85%
Material (jacket)	PUR
Material property (jacket)	CFC-, cadmium-, silicone- and lead-free, matt, low-adhesion, machine easy to process, abrasion-resistant
Shore hardness (jacket)	85 ±5 A
Outer-Ø (jacket)	6.7 mm ±5%
Color (jacket)	violet
chemical resistance	Oil resistance according to IEC 60811-2-1, ASTM IRM 901, ICEA S-82-552 Std.
thermal resistance	flame-retardant according to UL 1581 section 1090, section 1100 (FT2), IEC 60332-1-2 Std.
Nominal voltage	300 V
Test voltage	2000 V AC (test duration 1 min)
Temperature range (fixed)	-40...+80 °C

The information in this brochure has been compiled with the utmost care.

Liability for the correctness completeness and topicality of the information is restricted to gross negligence. Version: 03/22

Temperature range (mobile)	-30...+70 °C
Bend radius (fixed)	5× outer Ø
Bend radius (moving)	12× outer Ø
No. of bending cycles (C-track)	max. 3 Mio. (25 °C)
Travel speed (C-track)	max. 3.3 m/s
Acceleration (C-track)	max. 2 m/s ²

Commercial data

country of origin	DE
customs tariff number	85444290
EAN	4048879724302
eClass	27061801
Packaging unit	1.000