

Valve plug MJC 90° with cable V2A

PUR 2x0.75 bk 7.5m

Xtreme - Outdoor

Female 90°

0...230 V AC/DC

without components

Stainless steel 1.4305 (V2A)

Plastic housings with good resistance against chemicals and oils.

The resistance to aggressive media should be individually tested for your application. Further details on request.

Further cable lengths on request.

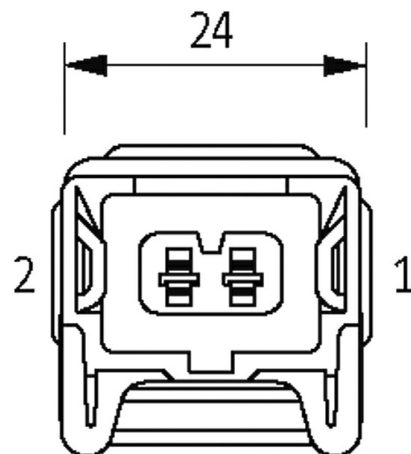
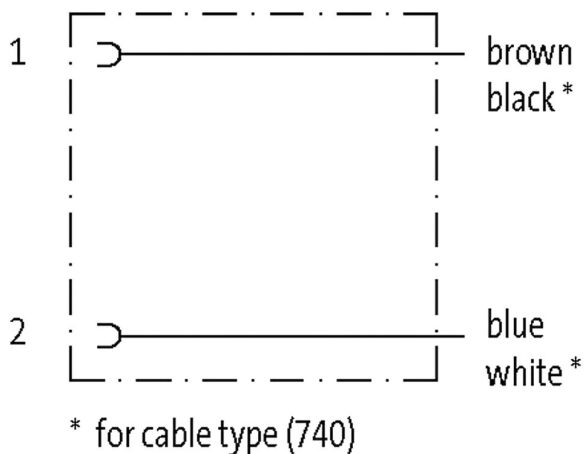
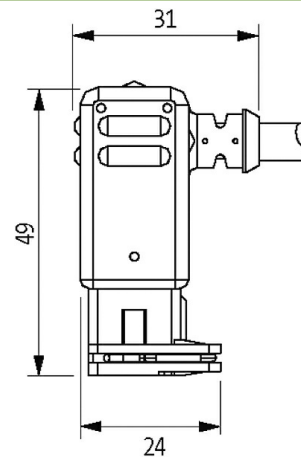
[Link to Product](#)**Illustration**

Product may differ from Image

Form

Form 70301

Technical Data

Operating voltage	max. 230 V AC/DC
Operating current per contact	max. 4 A
Housing	Black plastic, flame retardant
Protection	IP65 inserted and tightened (EN 60529)
Locking material	Stainless steel 1.4305 (V2A)

The information in this brochure has been compiled with the utmost care.

Liability for the correctness completeness and topicality of the information is restricted to gross negligence. Version: 03/22

Murrelektronik Ltd. | 5 Albion Street, Pendlebury Industrial Estate, Swinton | Manchester M27 4FG | Fon +44 161 728 3133 | Fax +44 161 728 3130 | shop@murrelektronik.co.uk | shop.murrelektronik.co.uk

General data

Temperature range	-25...+85 °C, depending on cable quality
-------------------	--

Cables

Cable number	750
No./diameter of wires	2× 0.75 mm ²
Wire isolation	PVC (br, bl)
Jacket Color	black
Material (jacket)	PUR/PVC
Outer Ø	5.9 mm ±5%
Bend radius (moving)	15× outer Ø
Temperature range (fixed)	-40...+80 °C
Temperature range (mobile)	-5...+80 °C
Cable identification	750
Approval (cable)	CE conform
Cable weight [g/m]	48,40
Material (wire)	Cu wire, bare
Resistor (core)	max. 26 Ω/km (20 °C)
Single wire Ø (core)	0.2 mm
Construction (core)	24× 0.2 mm (multi-strand wire class 5)
Diameter (core)	2× 0.75 mm ²
AWG	similar to AWG 18
Material (wire isolation)	PVC
Color/numbering of wires	br, bl
Stranding combination	2 wires twisted
Shield	no
Material (jacket)	PUR/PVC
Outer-Ø (jacket)	5.9 mm ±5%
Color (jacket)	black
chemical resistance	good resistance to oil, gasoline and chemicals
Nominal voltage	300 V AC
Test voltage	2000 V AC
Temperature range (fixed)	-40...+80 °C
Temperature range (mobile)	-5...+80 °C
Bend radius (moving)	15× outer Ø

Commercial data

country of origin	DE
customs tariff number	85444290
EAN	4048879312578
eClass	27279218
Packaging unit	1