

M12 female recept. A-cod. shielded rear

PUR 4x0.34 shielded bk UL/CSA+drag ch. 2m

Flange female

M12, 4-pole

shielded

Rear mounting

Further cable lengths on request.

The resistance to aggressive media should be individually tested for your application. Further details on request.

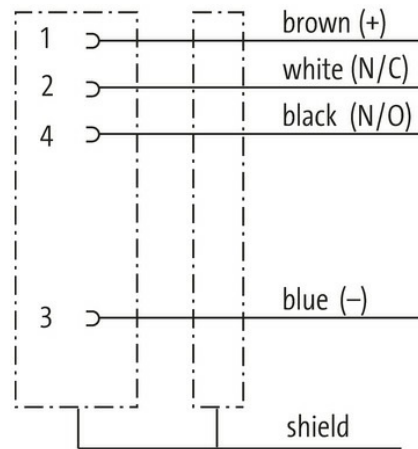
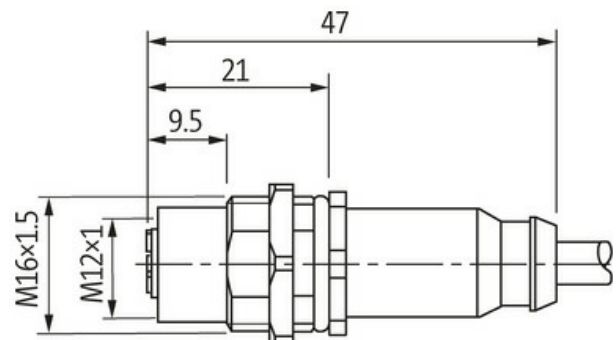
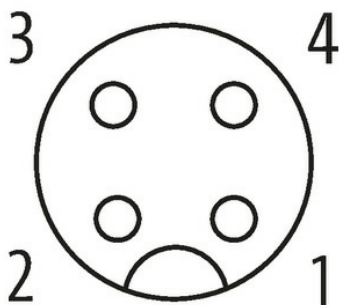
[Link to Product](#)**Illustration****Female**

Product may differ from Image

**Form**

Form 13611

Technical Data

Operating voltage max. 60 V AC/DC

Rated surge voltage	1.5 kV
Operating current per contact	max. 4 A
No. of poles	4
Material group	IEC 60664-1, category I
Coding	A-coded
LED display	no
Locking of ports	Screw thread (M12×1 mm) recommended torque 0.6 Nm, self-securing
Compression gland	M12 (SW14)
Protection	IP67 inserted and tightened (EN 60529)
Protection NEMA	3, 4, 6P (UL 50E)
Locking material	Brass, nickel plated

General data

Material (contact)	Copper alloy
Material (contact surface)	Au
Material (gasket)	FKM
Pollution Degree	3
Stripping length (jacket)	20 mm
Temperature range	-25...+85 °C, depending on cable quality

Cables

No./diameter of wires	4× 0.34 mm ²
Wire isolation	PP (br, wh, bl, bk)
C-track properties	5 Mio.
Outer Ø	5.3 mm ±5%
Cable identification	641
Cable Type	3 (PUR)
Approval (cable)	cURus (AWM-Style 20549/10493); CE conform
Cable weight [g/m]	50,6 g
Material (wire)	Cu wire, bare
Resistor (core)	max. 57 Ω/km (20 °C)
Single wire Ø (core)	0.1 mm
Construction (core)	42× 0.1 mm (multi-strand wire class 6)
Diameter (core)	4× 0.34 mm ²
AWG	similar to AWG 22
Material (wire isolation)	PP
Material property (wire isolation)	CFC-, halogen-, cadmium-, silicone- and lead-free
Shore hardness (wire isolation)	70 ±5 D
Wire-Ø incl. isolation	1.25 mm ±5%
Color/numbering of wires	br, bk, bl, wh
Stranding combination	4 wires twisted
Shield	yes
Material (jacket)	PUR
Material property (jacket)	CFC-, halogen-, cadmium-, silicone- and lead-free, matt, low-adhesion, machine easy to process, abrasion-resistant, hydrolysis and microbial resistant
Shore hardness (jacket)	90 ±5 A
Outer-Ø (jacket)	5.3 mm ±5%
Color (jacket)	black
Cable labeling	see frame delivery specifications 7000-00000-001
Jacket Color	black
Cable print	-
chemical resistance	good resistance to oil, gasoline and chemicals (EN 60811-404)
thermal resistance	flame retardand UL 1581 Section 1090 (H), CSA FT2 / IEC 60332-2-2
Nominal voltage	300 V AC
Test voltage	2000 V AC

Current load capacity	to DIN VDE 0298-4
Temperature range (fixed)	-40...+80 °C
Temperature range (fixed)	-40...+80 °C, (+90 °C at max. 10 000 operating hours)
Temperature range (mobile)	-25...+80 °C
Temperature range (mobile)	-25...+80 °C, (+90 °C at max. 10 000 operating hours)
Bend radius (fixed)	5× outer Ø
Bend radius (moving)	10× outer Ø
Bend radius (moving)	10× outer Ø
No. of bending cycles (C-track)	max. 5 Mio. (25 °C)
Travel speed (C-track)	max. 3.3 m/s
Acceleration (C-track)	max. 5 m/s ²
Torsion stress	±30°/m
No. of torsion cycles	max. 2 Mio. (25 °C)
Torsion speed	35 cycles/min
Material (jacket)	PUR (UL/CSA)

Commercial data

country of origin	DE
customs tariff number	85444290
EAN	4048879521024
eClass	27279220
Packaging unit	1.000