

M12 female 0° with cable

PUR (4x0.5C+2x0.5)C shielded ye 20m

Cube67

Female straight

M12, 6-pole

Actuator supply external

Further cable lengths on request.

Plastic housings with good resistance against chemicals and oils.

The resistance to aggressive media should be individually tested for your application. Further details on request.

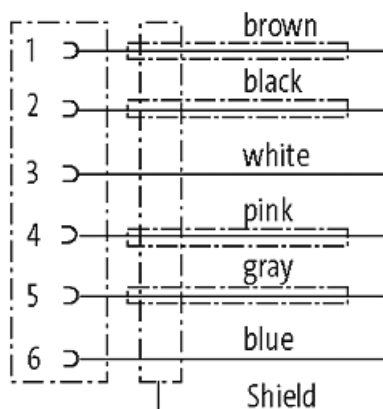
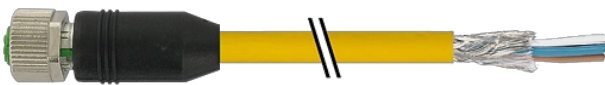
Link to Product**Illustration**

Female

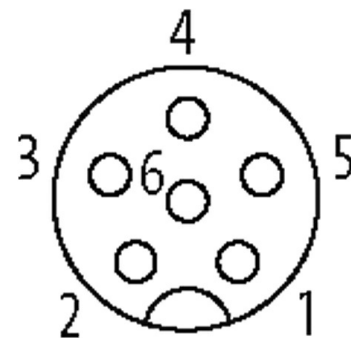

Product may differ from Image

**Form**

Form 15101

Technical Data

Operating voltage	max. 60 V AC/DC
Operating current per contact	max. 4 A
Locking of ports	Screw thread (M12x1 mm) recommended torque 0.6 Nm, self-securing
Protection	IP66K, IP67 inserted and tightened (EN 60529)

Cables

Cable number	138
No./diameter of wires	4× 0.5 + 2× 0.5 mm ²
Wire isolation	PP (br, wh, bl, bk, gr, pk)
C-track properties	5 Mio.
Jacket Color	yellow
Material (jacket)	PUR
Outer Ø	8.0 mm ±5%
Bend radius (moving)	10× outer Ø
Temperature range (fixed)	-40...+80 °C
Temperature range (mobile)	-5...+80 °C
Cable identification	138
Approval (cable)	CE conform
Cable weight [g/m]	123,20
Material (wire)	Cu wire, bare
Resistor (core)	max. 39 Ω/km (20 °C)
Single wire Ø (core)	0.15 mm
Construction (core)	28× 0.15 mm (multi-strand wire class 6)
Diameter (core)	4× 0.5 + 2× 0.5 mm ²
AWG	similar to AWG 20
Material (wire isolation)	PP
Material property (wire isolation)	CFC-, halogen-, cadmium-, silicone- and lead-free
Shore hardness (wire isolation)	55 ±5 D
Wire-Ø incl. isolation	1.5 mm ±5%
Color/numbering of wires	br, bl, gr, pk, wh, bk
Shield	yes
optical shield cover	min. 85%
Material (jacket)	PUR
Shore hardness (jacket)	85 ±5 A
Outer-Ø (jacket)	8.0 mm ±5%
Color (jacket)	yellow
chemical resistance	good resistance to oil, gasoline and chemicals (VDE 0472 Teil 803 Test B)
Nominal voltage	100 V AC
Test voltage	1200 V AC
Temperature range (fixed)	-40...+80 °C
Temperature range (mobile)	-5...+80 °C
Bend radius (moving)	10× outer Ø
No. of bending cycles (C-track)	max. 5 Mio. (25 °C)
Traversing distance (C-track)	max. 5 m (horizontal)
Travel speed (C-track)	max. 3.3 m/s
Acceleration (C-track)	max. 5 m/s ²

Commercial data

country of origin	DE
customs tariff number	85444290
EAN	4048879196925
eClass	27279218
Packaging unit	1