

M12 female 0° A-cod. with cable shielded

PVC 5x0.34 shielded bk UL/CSA 10m

Female straight
M12, 5-pole
shielded
with cable sleeves

Plastic housings with good resistance against chemicals and oils.

The resistance to aggressive media should be individually tested for your application. Further details on request.
Further cable lengths on request.

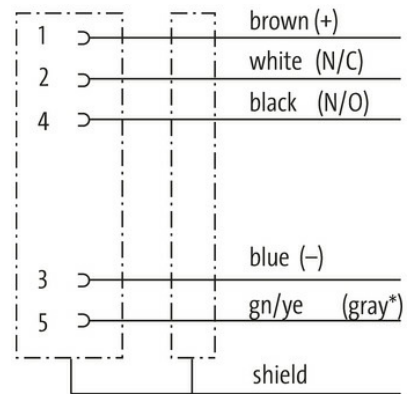
[Link to Product](#)**Illustration**

(* for cable type 203, 603, 243, 643)

Female

Product may differ from Image



* only for products with UL/CSA approved cable

Form

The information in this brochure has been compiled with the utmost care.
Liability for the correctness completeness and topicality of the information is restricted to gross negligence. Version: 03/22

Form	13221
Technical Data	
Operating voltage	max. 60 V AC/DC
Operating voltage (only UL listed)	max. 30 V AC/DC
Rated surge voltage	1.5 kV
Operating current per contact	max. 4 A
Material group	IEC 60664-1, category I
Coding	A-coded
Locking of ports	Screw thread (M12×1 mm) recommended torque 0.6 Nm, self-securing
Compression gland	M12 (SW13)
Protection	IP65, IP66K, IP67 inserted and tightened (EN 60529)
Material	PUR
Locking material	Zinc die casting, matte nickel plated
suitable for corrugated tube (internal Ø)	without
General data	
Standards	DIN EN 61076-2-101 (M12)
Pollution Degree	3
Stripping length (jacket)	20 mm
Temperature range	-25...+85 °C, depending on cable quality
Cables	
No./diameter of wires	5× 0.34 mm ²
Wire isolation	PVC (br, wh, bl, bk, gr)
Outer Ø	5.6 mm ±5%
Cable identification	603
Cable Type	1 (PVC)
Approval (cable)	UL (AWM-Style 2464/1731), CSA
Cable weight [g/m]	68,2 g
Material (wire)	Cu wire, bare
Resistor (core)	max. 60 Ω/km (20 °C)
Single wire Ø (core)	0.15 mm
Construction (core)	19× 0.15 mm (multi-strand wire class 5)
Diameter (core)	5× 0.34 mm ²
AWG	similar to AWG 22
Material (wire isolation)	PVC
Material property (wire isolation)	CFC-, cadmium-, silicone- and lead-free, matt, low-adhesion, machine easy to process, abrasion-resistant
Shore hardness (wire isolation)	59 ±5 D
Wire-Ø incl. isolation	1.25 mm ±5%
Color/numbering of wires	br, bk, bl, wh, gr
Stranding combination	5 wires twisted around central filler
Shield	yes
optical shield cover	min. 80%
Material (jacket)	PVC
Material property (jacket)	CFC-, cadmium-, silicone- and lead-free, matt, low-adhesion, machine easy to process, abrasion-resistant
Shore hardness (jacket)	85 ±5 A
Outer-Ø (jacket)	5.6 mm ±5%
Color (jacket)	black
Jacket Color	black
chemical resistance	good resistance to oil, gasoline and chemicals
thermal resistance	flame retardant UL 1581 VW1 / CSA FT1
Nominal voltage	300 V AC
Test voltage	2000 V AC
Current load capacity	to DIN VDE 0298-4

Temperature range (fixed)	-30...+80 °C
Temperature range (fixed)	-30...+80 °C
Temperature range (mobile)	-5...+80 °C
Temperature range (mobile)	-5...+80 °C
Bend radius (fixed)	10× outer Ø
Material (jacket)	PVC (UL/CSA)

Commercial data

country of origin	CZ
customs tariff number	85444290
EAN	4048879758161
eClass	27279218
Packaging unit	1.000