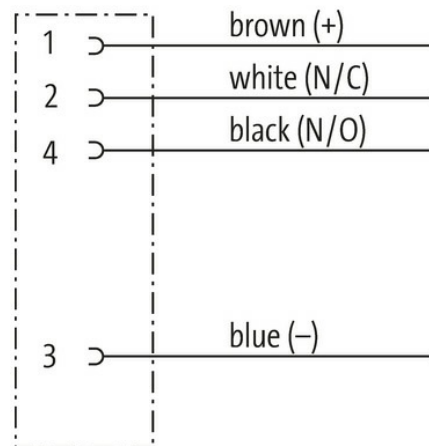
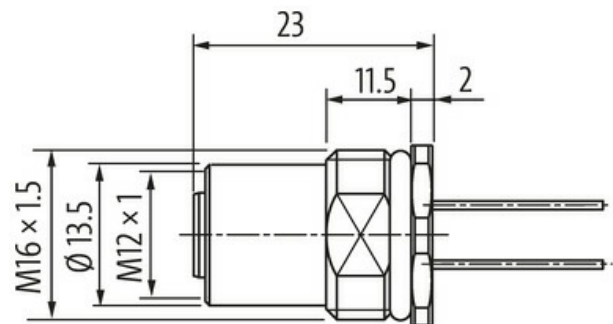
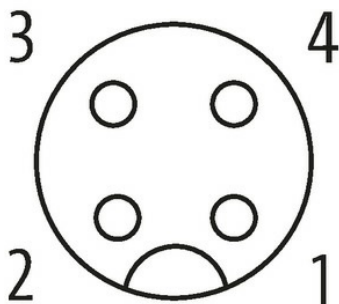

M12 female recept. A-cod. rear

PP-wires 4x0.34 0.2m

Flange female
M12, 4-pole
Rear mounting
with multi-strand wire

[Link to Product](#)**Illustration****Female**

Product may differ from Image

**Form**

Form 13545

Technical Data

Operating voltage	max. 250 V AC/DC
Rated surge voltage	2.5 kV
Operating current per contact	max. 4 A

No. of poles	4
Material group	IEC 60664-1, category I
Coding	A-coded
LED display	no
Locking of ports	Screw thread (M12×1 mm) recommended torque 0.6 Nm, self-securing
Compression gland	M12 (SW14)
Protection	IP67 inserted and tightened (EN 60529)
Protection NEMA	3, 4, 6P (UL 50E)
Material	Brass, nickel plated
Locking material	Brass, nickel plated
suitable for corrugated tube (internal Ø)	without

General data

Standards	DIN EN 61076-2-101 (M12)
Material (contact)	Copper alloy
Material (contact surface)	Au
Material (gasket)	FKM
Pollution Degree	3
Temperature range	-25...+85 °C

Cables

No./diameter of wires	4× 0.34 mm ²
Wire isolation	PUR
Outer Ø	1.3 mm ±5%
Cable number	971
Temperature range (fixed)	-40...+90 °C
Temperature range (mobile)	-25...+90 °C
Bend radius (fixed)	5× outer Ø

Commercial data

country of origin	DE
customs tariff number	85444290
EAN	4048879329989
eClass	27279220
Packaging unit	1.000